

# RAINBOW

11  
YEARS

THE COLOR COMPUTER MONTHLY MAGAZINE

June 1992 Vol. XI No. 11

Canada \$4.95 U.S. \$3.95



Pause Switch

See Page 10

Feature Program

## New Clear-screen Routines: ML and the CoCo 3

Machine language (ML) has many advantages over BASIC. Most users know machine-language programs run considerably faster than those written in BASIC. It is also possible to write ML programs so that they run in the "background," leaving the computer free to perform other tasks (simple multitasking). Yet another interesting difference is that machine language on the CoCo 3 gives us the power to alter the BASIC language.

The three machine-language programs presented here are examples of how I modified the CoCo 3 system to change the way the CLS command works. The programs are quite simple and most lines are commented, making them easy to follow.

### Trapping The CLS Command

Every time a valid command is encountered, the CoCo executes a machine-

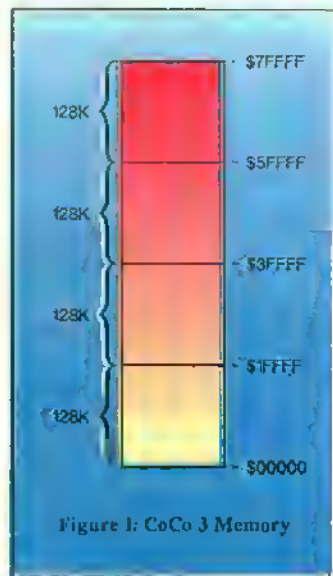

Figure 1: CoCo 3 Memory

language subroutine in the BASIC ROM to perform the desired function. For example, when you enter CLS, the computer goes to a "command table" stored in the ROM and searches for the CLS command. Once it finds the entry for CLS, the CoCo deter-

mines where the routine starts and jumps to the appropriate address to execute the command.

The CLS command used for the CoCo 3's 32-column screen begins at Memory Location \$A928 (decimal 43304). We can "trap" the CLS command by placing a machine-language branch instruction at this address, pointing the CoCo in the direction of a different routine we want it to execute.

To get an idea of how this works, look at Line 160 of Listing 1. The DRG statement directs the assembler to locate the succeeding code at Address \$A928, the "hook" for CLS. What the assembler stores there is a long-branch instruction telling the computer to jump to Address \$01DA, which is where we'll put the

rest of our new CLS routine.

The second DRG (Line 190) tells the assembler to store the new routine starting at Address \$01DA. This is where the cassette buffer ordinarily resides in the CoCo. As written, the programs presented here cannot be used with a tape-based system. If a cassette command (CLOAD, CSAVE, etc.) is entered, any information stored in this area of memory will be destroyed — the new routine will be erased. (You can move the routines to another location if this presents a problem.)

### Using the Hi-Res Screens

The two programs shown in listings 2 and 3 are intended for the CoCo 3's 40- and 80-column screens. They are a bit more complicated since we must use other tricks to gain access to these areas through machine language.

As most CoCo users know (or will soon find out), the 6809 microprocessor can address only 64K of memory. The CoCo 3's GIME chip, however, includes a memory-management unit (MMU) that allows the CoCo to address up to 512K of memory. The MMU does this by splitting the entire CoCo memory into 8K blocks, then mapping eight of these blocks into the 6809's address space as requested.

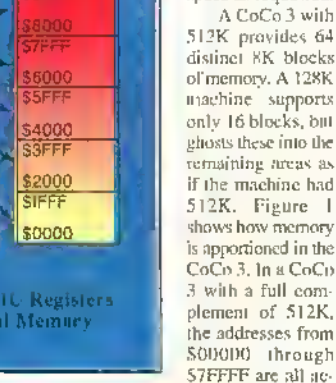

Figure 2: MMU Registers and Virtual Memory

rest of our new CLS routine. With 128K, only the top See Clear-screen Routines on Page 17

Feature Program

## CoCo Writes Purchase Orders

CoCoPO is a very handy little program, especially if you like to take advantage of the wonderful offers you see advertised in THE RAINBOW and other magazines. Over the past several years I have purchased a considerable amount of Color Computer software and hardware through third-party vendors, as well as from my local Radio Shack. Until I bought my CoCo 3, I used William Boston's Mail Order program (THE RAINBOW, August 1982) to handle purchase orders and found it to be a great help. However, I felt certain features could make the program a bit more functional, so I've added them. Still, Mr. Boston's program provided an excellent model from which to work.

CoCoPO is designed for the Color Computer 3 and uses the 80-column screen — you'll need an RGB or monochrome monitor to use it effectively. The program is menu-driven and quite easy to use. After running CoCoPO, start by selecting Option 1 (Enter Data). From this point, simply respond to the prompts.

After you fill in the address of the company from which you are ordering, the screen "form" appears. At the bottom of the screen is a prompt asking for the number of entries; if you are ordering more than one type of item, indicate here how many lines you will need. Enter just the numerical values at all prompts for prices — the pro-

See Purchase Orders on Page 30

### In this issue:

Back Issue Information	14
Bar Graph Printer	14
Charles Kiedalsh	24
Beat the Bomb Word Game	24
John Sava	22
Card-Player's Surl	6
George R. Mabry	6
Clean the CoCo 3 Screen	1
Jason Dessel	1
CoCo 3 Screen Expander	24
Ron Dahlke	24
CoCo Consultations	4
by Marty Goodman	4
CoCo Writes POs	1
Roger F. Knauer	1
Convert PRINT@ Statements	14
Mike Woolridge	14
Delphi Bureau	18
by Eddie Kuns	18
Letters to Rainbow	2
Motchkmer, Matchmaker	16
Kevin Speight	16

Pause Switch	10
Jeff Steidl	10
Pretty Print With OS-9	8
Stephen Goldberg	8
Print# 2	2
by Lonnie Falk	2
Print to the Screen and Printer	6
James Provost	6
Received and Certified	22
Serial Communications	27
Gary Kessler	27
Star Grabber Game	11
Jim McDowell	11
Turn the World	12
Barry Mitchell	12

Product Reviews:	
CuCu Family Recorder	15
Furnu Systems	15
Desk Accessory Pack	13
from Cer-Comp, Ltd.	13
Unbelievable Offer #3	26
Rick's Computer Enterprise	26

## THE RAINBOW

Editor and Publisher  
Lawrence C. Falk

Managing Editor Clay Augsburg  
Associate Editor Sue Formby  
Submissions/Reviews Editor Tony Olive  
Technical Editor Greg Law  
Technical Assistants Ed Eilers,  
Gregory Shultz  
Editorial Assistant Julie Hutchinson  
Contributing Editors Tony DiStefano,  
Martin Goodman, M.D., Eddie Kuns  
Art Director Heidi Nelson  
Designers Sharon Adams, Teri Kays,  
Consulting Editors Judi Hutchinson,  
Laurie D. Falk  
Typesetter Debbie Diamond

## Falsoft, Inc.

President Lawrence C. Falk

General Manager Peggy Lowry Daniels  
Asst. General Mgr. Ioi Finence  
Donna Shuck

Admin. Asst. to the Publisher  
Kim Thompson

Editorial Director John Cringley  
Director of Creative Services  
O'Neil Arnold

Chief Bookkeeper Diane Moore  
Dealer Accounts Toni Georgia

Asst. Gen. Manager For Administration  
Tim Whelan

Corporate Business Technical Director  
Calvin Shields

Customer Service Manager  
Beverly Beeden

Customer Service Representative  
Patricia Eaton

Chief of Printing Services Melba Smith  
Business Assistant Wendy Falk Barsky

Chief of Building Security and Maintenance  
Lawrence Johnson

Asst. General Manager for Advertising,  
Development and Production  
Ira Bersky

Advertising Representatives Belinda Kirby,  
Kim Lewis

Advertising Assistant Carolyn Fanwick  
(502)228-4492

For RAINBOW Advertising and  
Marketing Office Information,  
see Page 31.

THE RAINBOW is published every month of the year by FALSOFT, Inc., The Falsoft Building, 9509 U.S. Highway 42, P.O. Box 385, Prospect, KY 40059, phone (502) 228-4492. THE RAINBOW, RAINBOWtype and THE RAINBOW and RAINBOWtype logos are registered trademarks of FALSOFT, Inc. • Second class postage paid Prospect, KY and additional offices. USPS N. 705 950 (ISSN No. 0748-4737), POSTMASTER, Send address changes to THE RAINBOW, P.O. Box 385, Prospect, KY 40059. Authorized as second class postage paid from Hamilton, Ontario by Canada Post, Ottawa, Ontario, Canada under Sales Agreement #49077. • Entire contents copyright © by FALSOFT, Inc., 1992. THE RAINBOW is intended for the private use and pleasure of its subscribers and purchasers and reproduction by any means is prohibited. Use of information herein for the single use of purchasers and any other use is expressly prohibited. All programs herein are distributed in a "flat" basis without warranty of any kind whatsoever. • Tandy, Color BASIC, Extended Color BASIC and Program Pak are registered trademarks of the Tandy Corp. • Subscriptions to THE RAINBOW are \$31 per year in the United States. Canadian rates are U.S. \$36. Surface mail to other countries is U.S. \$66, or mail U.S. \$103. All subscriptions begin with next available issue. • I mailed back issues are available. Please see notice for mailing instructions and their costs. Payment accepted by VISA, MasterCard, American Express, cash, check or money order in U.S. currency only. Full refund after mailing of one issue. A refund of 10% of the subscription amount after two issues are mailed. No refund after mailing of three or more magazines.



## Programming: Getting There From Here

In his new book *Accidental Empires* (a history of the last decade of the computer era — with special emphasis on the PC and Apple environments), Robert Cringley points out that what got people into computers in the beginning was programming. I believe Cringley is correct and that, to a great degree, this is why the Color Computer has always been so successful.

Certainly there are plenty of people who just want to buy applications, load them into their computers, and run them. Heck, by and large, I am one of these people. But what happens when there is no program? Or what if what you want the computer to do is something simple? The answer is programming.

This is why there have always been program listings in THE RAINBOW. Of course many of you buy the magazine, at least in

part, to get the "free" programs. But the truth of the matter is that "giving" you programs is only one of our goals.

Another goal we have is to teach a little "light" programming here and there. And it is a worthy thing to do. Let me explain.

I cannot add two numbers together particularly effectively. Despite the fact that my father promised me \$5 for every multiplication table I memorized, the 7's and 8's are still pretty much a mystery to me. So what I needed early on was a simple little program to add, subtract, multiply and divide numbers. Sure, it would have been easy enough to load a spreadsheet or one of those multifunction utilities, but that was overkill when all I wanted to do was add a few numbers together.

Programming was (and is) the solution. It is easy to write a program in BASIC to perform the four basic calculator functions.

Nowadays we load lots of programs at one time (using subroutines or OS-9), and we can do all sorts of fancy things. Yet I still use my own variation of the "adding machine" much of the time. I am sure many of you do similar things as well.

The point Cringley makes is that early on in the computer era, if you wanted a program that performed a particular task, generally you wrote it yourself. My point is that, even with the huge body of CoCo software available, there will always be some things you will want to do yourself. I also believe it is worth your time to learn

something about programming. This is why we put some emphasis on the subject in THE RAINBOW.

We will continue to emphasize this learning process monthly, if in no other way than by printing programs and showing you how they work. Sure, type in the listings (or get RAINBOW ON TAPE/DISK); but take the time to see how the program is constructed, too — what tricks the programmer uses, and how you can apply the techniques to the things you want to do.

**E**ven with the huge body of CoCo software available, there will always be some things you will want to do yourself.

No, you do not have to be a programmer to use a computer. But I think it will increase your enjoyment of your CoCo if you delve into it a bit.

— Lonnie Falk

## Letters to the RAINBOW



### About Your New Look . . .

Editor:

My hat's off to you for the new format of THE RAINBOW. Although it is a bit bulkier, it sure is easier to read without the annoying glare found with the old slick pages. I am hopeful the changes will not be cosmetic only. Please return to the fat information-packed issues of yesteryear — perhaps a systematic reprinting of selected articles from early issues.

Many thanks and keep on serving us that good CoCo information.

Donnie Pardue  
133 Lavigne Drive  
Sanford, NC 27330

Editor:

The new tabloid format for THE RAINBOW is, well, functional. The important thing is it arrived — and that you're still supporting the CoCo. I must say that I long for the cheerful, funky, happy format and cover art of the middle 1980s, but then such is life. Again, thanks; Tandy is no longer with us.

Dale Hawley  
3223 NE 89th St.  
Seattle, WA 98115

Editor:

I have enjoyed THE RAINBOW for several years. I want you to know that I am not satisfied with your recent change. It is easier to store and look up back issues in book form.

If your magazine continues to come in a newspaper form, I will let my subscription lapse.

Lloyd Bledsoe  
P.O. Box 169  
Oxford, WI 53952

Editor:

A number of years ago I used a program called *Master Control Run* my CoCo 1, but

I have since lost this utility. It was written by Alnn Schwartz and put out by Soft Sector Marketing. The program generated BASIC commands with a keystroke — a great time saver when writing programs. Does anyone know where I can find it or another program like it for my CoCo 3?

Though I am sad to see the magazine style dropped, I hope the new format is more affordable to publish and better for the environment. Most of all, I hope it will yield more space for letters and articles on the CoCo's workings. We learn so much from other people's questions.

Alun Doherty  
169 White Moss Drive  
Mansions Mills, MA 02648

Editor:

With my 512K CoCo 3 and programs such as *Teletwritr 128*, *CHI PagesE*, *CoCo Max III*, *High Finance*, *Dam Windows*, *Dynacalc* and many others (along with all the power and convenience of multitasking) I can do virtually anything that is accomplished with personal computers today.

I admit VGA would be nice, but not enough for me to go out and spend \$1000 or more and start over with a different system. No, I'm sticking with my CoCo 3. It has all the capability I need in a computer.

So keep THE RAINBOW coming, even if you have to go back to using that drugstore copier!

Thomas Farn  
534 Morley Avenue  
Akron, OH 44320

Editor:

My gut feeling is that you should keep THE RAINBOW alive and in print, even if it must be on pulp newsprint. I know nothing about the publishing business. However, I do observe all the standard-sized magazines in my bookstore that obviously have a small audience (various hobbies and home crafts); though they have little advertising, they still survive.

I have all THE RAINBOWS (from the beginning) carefully saved and frequently use them. My main concern is whether the new format and the paper used will stand the test

of time or, like yesterday's newspaper, oxidize to brittle dust in a short time.

Besides my CoCo, I own a Tandy 1000 TL/2 with all the bells and whistles. It's a nice machine. But where do I go when I want to get something done smoothly and easily? To my CoCo. Sure, it's slower than bigger expensive machines, but I'm not a corporation, and I'm not especially in a hurry.

Magazines directed toward MS-DOS machines (PCM included) use most of their space describing what you can buy to do wonderful things for expensive prices. They provide very few programs you can type in yourself. A big joy of getting THE RAINBOW is to read, understand and type in a new way to do something. Even if you buy RAINBOW ON TAPE or DISK, the discussion of what, why, and how the program worked is there in THE RAINBOW. It is an education, not just a set of directions.

Somewhere in the thousand programs I've collected for CoCo, there's a BASIC or OS-9 program that will do almost everything that programs for MS-DOS accomplish. Long live the CoCo, and long live THE RAINBOW.

Pete Edmondson  
111 Windsor Lane  
New Brighton, MN 55112

Editor:

I want to comment on your change from your magazine to a newspaper-type magazine. It is my opinion that the publishers of THE RAINBOW have made a mistake! How do we store or stack (or handle for that matter) this beast you have laid on us! I know expenses and profits play a big part in the decision-making process. Personally I would rather pay \$1 a year extra for my subscription than to suffer with the new format, which in my opinion is a step (or maybe two) backwards. Please reconsider going back to being a legitimate magazine.

E.J. Oelshlager  
1242 Morrow Rd.  
Pittsburgh, PA 15241

Editor:

Congratulations on your innovative new

format. You have given us larger print, larger ads, and more and better editorial content without raising the cost of the subscription. If it took slick paper to make a great publication, the *New York Times* and *Washington Post* would have slipped into obscurity long ago.

Your advertisers need to be reminded that Tandy has just about dumped all the CoCo hardware and software they had on the market. Other vendors surely suffered while people like me were picking up deals (such as *DeskMate 3* for \$2.95). But now there are thousands of us CoCo users who are relying solely on these vendors for our continuing hardware and software needs, and we're reading THE RAINBOW to find out about the products they sell.

Charles Radatz  
KTNC Radio  
P.O. Box 589  
Fallis City, NE 68355

#### Editor:

I was sorely disappointed when I received the latest issue of THE RAINBOW. I knew it was dwindling in size, but I was still able to file it in my library. I don't know how I can keep this format in good enough shape that I can refer to it—it is too big and has to be folded, and that tends over a time to ruin the magazine. I have two CoCo 3's and all the attachments. I also have hundreds of programs I have bought over the years. I still like the material you put in the magazine; but, I hope you can reproduce it in a size that can be filed in my yearly boxes.

I can afford to buy a PC-compatible, but the CoCo does all I want to do (even without having to learn OS-9 and C, though I appreciate the abilities of others who can use them and allow me to profit from their work). I will stay with the CoCo as long as I need it.

A.F. Robinson  
Route 2, Box 2546-A  
Boerne, TX 78006

#### Needs a Disk Drive

#### Editor:

I am looking for a Radio Shack (or compatible) disk-drive system for a Color Computer 2. Can someone help me locate one? I know I may also need an operating system.

Robert Simpson  
5720 Rossmore Drive  
Bethesda, MD 20814

Several RAINBOW advertisers offer disk-drive systems for the Color Computer. Check the ads from CoCo PRO!, Computer Plus and Owl-Ware in this issue. Drive 0 systems usually include Disk BASIC, a general operating system for the CoCo.

#### Skipping the Perforations

#### Editor:

I have a CoCo 3, an FD-501 disk drive, a DMP-430 printer and an MPI PrintMate 99 Printer. I use the CoCo primarily for word processing, and I'm having some real problems with both printers. They print over the perforations, then skip spaces for the perforations a few lines down from the top of the page. It doesn't matter how I set the DIP switches. Can you tell me how the switches need to be set on either printer (or both)?

Keith Johnson  
Route #1, Box 322  
Plymouth, UT 84601

Perhaps others can give you specific information on DIP-switch settings, but if the misalignment is the same on all pages, we suggest you start the paper a little lower in the printer. With many "pull-feed" print-

ers, this is impossible—you must waste a whole piece of paper to start near the top of the next sheet.

#### Teach My CoCo to Talk

#### Editor:

I'm in desperate need of an inexpensive speech system for my CoCo 3. Do you know where I can get one? Also, where can I find software to transfer files between a CoCo and an MS-DOS computer? Can I transfer files without using a modem? I would appreciate any help you could give me.

John Sava  
618 N. Townsend Street  
Syracuse, NY 13203

Elite Software and Granite Computer Systems offer utilities that can be used to transfer files between Disk BASIC and MS-DOS. Granite's system also supports OS-9 transfers. Also refer to the following two RAINBOW articles by Marty Goodman: "The Great Transformation" (June 1986, Page 182) and "CoCo to MS-DOS" (July 1986, Page 176).

#### Not Just Whistlin' Dixie

#### Editor:

I recently joined a Civil War reenactment group and am now looking for any Civil War programs for the CoCo. I am looking for programs of any type (e.g., games, education, Civil War stats). Can anyone help? I have a CoCo and a CoCo 3, a disk drive, a printer and a modem.

F. Jeff Chandler  
184 Muldown Road  
Saxsex, NJ 07461-3616

#### CCTools: An Open Letter

#### Editor:

Micro 80 Users Group of Winnipeg, Manitoba, submitted CCTools to several BBSs last year. We have had a number of requests for the CCTools package. Unfortunately some of our subscribers sent personal checks instead of money orders. This causes quite a delay since the check has to clear before we can send out the CCTools package; an extra delay is involved if the check is from outside Canada. To make matters worse, a mail strike occurred just as we were starting to ship CCTools. One subscriber didn't get his package. When he wrote to inquire about it, we sent another package to him. We are sorry that this user was inconvenienced and disappointed in the shareware concept.

We will certainly do our best to make CCTools available to anyone as soon as they send for it. As stated in the distributed application and in the documentation, send no checks please—money orders only. For serious more-capable OS-9 users, CCTools is an environment that makes file, disk and utility management, as well as application launching, simple and fast.

Micro 80 Users Group  
598 Riverton Avenue  
Winnipeg, Manitoba  
Canada R2L 0P1

#### OS-9 in Germany

#### Editor:

In have read in THE RAINBOW about the OS-9 programs Multi-View and Multi-View. What is the difference between them, and where can I get them? I have asked several Tandy stores in the U.S., but nobody seems to know. There are no Radio Shack stores in Germany.

I have problems trying to contact Tandy. I have written some letters but gotten no answers. Do you know a phone number I can use to ask about Tandy products?

I did manage to get OS-9 Level II and the

Development System. I received the disks and the documentation, but I didn't get a three-ring binder. Every time I use the manual, I end up with quite a mess on my writing desk. Where can I get an appropriate binder? (In Germany we have binders that have four rings.)

Eberhard Pflug  
Athenberger Gasse 181  
D-5303 Bornheim 4  
West Germany

Prior to its introduction, Multi-View was often erroneously referred to as Multi-View. They are the same product. To the best of our knowledge, they are available only through Tandy's Express Order Service. You can contact Tandy by calling (817) 390-3011. Three-ring binders are available from most office supply companies in the U.S.

#### Lending a Helping Hand

#### Editor:

One of the many ways I use the Color Computer is by providing computer activities for the children in my wife's daycare center. My old CoCo 2 has become the official daycare computer. The challenge has been to write programs that are appropriate for children from ages 2 through 5. I use CoCo Max II and Music+ to create graphics and music. Also, I bought the "Electronic Book" back when it was available from Radio Shack. I have found this is the only interface that children at these ages can use with ease.

The only problem we have is that many of the programs we use require synthesized speech, and the children frequently cannot understand the speech produced by the Radio Shack Speech/Sound Cartridge. I believe the Super Voice synthesizer, which was advertised a while back in THE RAIN-

BOW, would be the solution to our problem. However, I have been unsuccessful in locating even a used one. I am appealing to RAINBOW readers for help. I am interested in hearing from anyone who has Super Voice and would be willing to sell it to me for a reasonable price. It would be put to an extremely good use. Thank you.

Jim Bennett  
118 Corlies Avenue  
Poughkeepsie, NY 12601

#### Kudos

#### Editor:

You are doing a great job! Continue this, and I'll read THE RAINBOW for a very long time. Thanks to you, I have learned more about computers in the past 10 years than I had learned before I discovered THE RAINBOW. I have also met new friends, and you have helped me decide what career I will choose in college. Once again, thank you very much.

Luis Tanon  
Calle #2, M-12  
Dos Rios, Bayamon  
PR 00957

THE RAINBOW welcomes letters to the editor. Mail should be addressed to: Letters to Rainbow, The Falstaff Building, 9509 U.S. Hwy 42, P.O. Box 385, Prospect, KY 40059. Letters should include the writer's full name and address. Letters may be edited for clarity or to conserve space.

Letters to the editor may also be sent to us through our Delphi CoCo SIG. From the CoCo SIG> prompt, enter RA1 to get to the Rainbow Magazine Services area of the SIG. At the RAINBOW> prompt, enter LET to reach the LETTERS> prompt, then select Letters for Publication. Be sure to include your complete name and address.

Over  
\$600 in  
software

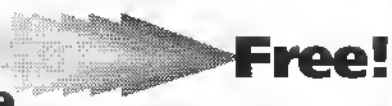

Free!

**NO CATCH GIVEAWAY.** We at CoCoPRO! are eager to meet new friends who use CoCos, and can think of no better way to make them than by **giving away** this fabulous collection of software to one lucky person...and that lucky person **could be you!**

**EASY TO ENTER.** Simply send a postcard or letter with your name, complete address, telephone number, a brief description of your hardware setup, and indicate whether you use RSDOS, OS9, or both. **Entries must be received by July 15, 1992.** One entry per household. On or about July 15, a representative of accounting firm Baker & Assoc. will draw one lucky winner from all entries meeting the above criteria...and **that winner could be you.**

**THE PRIZE PACKAGE.** OS-9 Lv. 2 Development System, Simply Better, Newspaper09, NewsART09, NewsFONTS, V-Term, Disk Manager Tree, Tools II, Lv. II Tools, Presto Partner, Multi-Menu, Zapper, Carmen San Diego, OS9 lv 2 BBS, FlightSim II, CoCoPRO! Solitaire. All require a CC-3, some require OS-9 lv 2.

Send entries to:

**COCO PRO!**  
PO Box 763 Ypsilanti, MI 48197

Entries not containing all requested information, or not received on or before July 15, 1992, may be disqualified.



**Interfacing With the System Bus**  
*How do I interface hardware projects to the Color Computer system bus? Are prototyping boards available to assist me with making custom interface cards?*

Dustin Mollo (DOCMOLLO)  
 Forestville, California

**A** Interfacing to the CoCo system bus is relatively straight-forward. The 6809 uses memory mapping for I/O. The I/O space for the CoCo 3 is \$FF00 through \$FFF7E, but much of this area is taken up by various parts of the CoCo system itself. If you are using a Multi-Pak Interface or Slot Pak III, you can simplify address decoding by using the \*SCS line. This line is active low for addresses \$FF40 through \$FF5F. If you use the \*SCS line, however, make sure you switch (via software) to the slot that holds the device before attempting to address it.

You can use a GAL chip or small-scale logic chips (the 74LS30, 74LS133, and 74LS688 come in handy) with the address lines to decode for other parts of the I/O space. Addresses \$FF60 through \$FF7E are available, though you should stay away from \$FF68 through \$FF6F, which is used by one of two UART devices on most systems. I am told that addresses \$FF10-\$FF1F and \$FF30-\$FF3F in the CoCo 3 are also available — in a CoCo 1 or 2, these addresses conflict with the PIA chips, which “ghost” into that address space. You’ll want to gate any memory or I/O with the E-clock line, too, making sure that accesses occur only when the E clock is High. The 6809 uses a single R/\*W line to control the direction of its 8-bit data bus.

CRC/Disto at one time offered an excellent Color Computer system-bus prototyping card — I used them for several projects and recommend them highly. CoCo PRO! may still be able to sell you some of these. If they are no longer available, you can make your own by scrapping other kinds of cards.

**Transferring Big Files**

*I need to copy over half a megabyte of data (in the form of a random access file, for which I know the data-table format) from a CoCo running OS-9 to MS-DOS. What software and/or hardware do you suggest I use?*

James W. Kerr  
 Ft. Myers, Florida

**A** Since this is a one-time transfer, I recommend you use terminal programs — one on the CoCo and the other on the MS-DOS computer. Any terminal programs that support Xmodem or Ymodem should be adequate, and there are a great many to choose from for both OS-9 and MS-DOS systems.

Link the two computers by using a null-modem cable between their serial ports. Since you are running OS-9, I assume you are using a Multi-Pak Interface (or Y cable) and an RS-232 pack of some kind. Given this, it is fairly easy to make a null-modem cable to go between a PC-compatible with a DB-25 connector for its RS-232 port and the DB-25 on the CoCo serial pack. Pins 2, 3 and 7 on the CoCo end should go to pins 3, 2 and 7, respectively, on the PC DB-25. Connect Pin 4 to Pin 5 on the CoCo end,

then connect Pin 4 to Pin 5 on the PC end — but don't connect the CoCo end to the PC end. Similarly connect Pins 6, 8 and 20 together in each end. (See Figure 1)

If your PC compatible uses a DB-9 connector for its serial port, connect pins 2, 3 and 7 on the CoCo's DB-25 to pins 2, 3 and 5, respectively, on the DB-9 (as opposed to the way we wired the DB-25 above). On the CoCo side connect pins 4 and 5 together and pins 6, 8 and 20 together, as described above. On the PC side, wire together pins 7 and 8. Also wire together pins 1, 4 and 6 on the DB-9 connector. (See Figure 2)

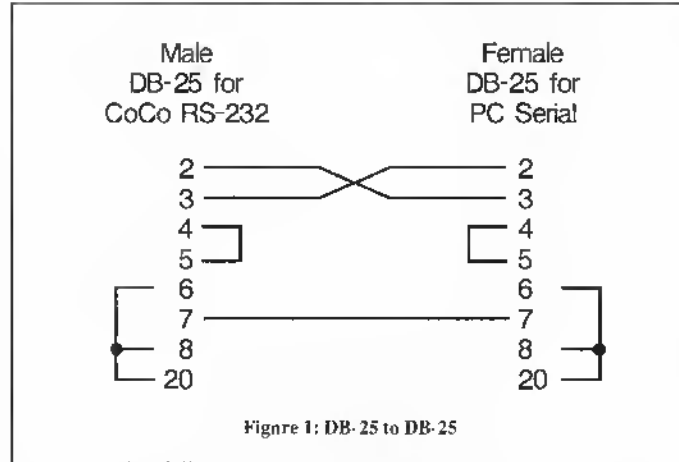

Figure 1: DB-25 to DB-25

Use the new cable to link the serial ports on the two computers and run a terminal program on each machine. Be sure you use the same communications speed on both machines. (I recommend using the fastest rate you can — probably 2400 bps.) Try typing a few letters on each keyboard, to make sure the same letters appear on the screen of the other machine. Once this is working, tell the PC to start an Xmodem receive and tell the CoCo to initiate an Xmodem send of the file you want to transfer. This should bring the file over.

Several OS-9 utilities are available for reading and writing MS-DOS disks. But for a single transfer, it may not be practical to buy such software.

**Printout Slowpoke**

*When I send data from Max-10 to my DMP-130 printer at 2400 bps (the fastest speed the 130's internal serial port accepts), it takes 30 minutes to print a page. This is just too long for me. Would a parallel interface help me achieve faster results?*

Arthur R. Hinman  
 Hummelstown, Pennsylvania

**A** Unless you use a sizeable printer huffer along with a serial/parallel converter, you won't get much better performance using the parallel port. Note that a serial/parallel converter is essential for looking a Color Computer to a parallel printer port (unless you have a special hardware parallel port adapter of the sort that comes with certain Disto mini-expansion boards and some J&M disk controllers, along with appropriate software). Max-10 is slow to print because it prints a “bit image” of the page in the printer's graphics mode. This requires far more data be sent to the printer than would be the case if the program used the available fonts in the printer and sent or by ASCII text to the printer. Unless you need the desktop publishing capabilities of Max-10, you might consider using another word processor. Max-10 exacts a heavy price in printing speed for its great flexibility in the printing of fonts.

**Swapping Printer Boards**

*Is there a board that can be swapped or installed in a Star Micronics NX-1060 with a Commodore interface to convert it for RS-232 input?*

*I found that cutting slots over the power transformer and power regulator in my CoCo 3 significantly reduced the heat level inside the case. This may be a quick and simple alternative to redesigning the power supply in CoCos that suffer overheating problems.*

Doug Pirkey  
 New Cumberland, Pennsylvania

DOS computer with a 5/4-inch 360K drive. This PC-based hardware from Central Point Software can copy any copy-protected disk produced for the Color Computer (with one exception, a case in which the media was intentionally damaged in a particular spot).

**Connecting to Ma Bell**

*How do I hook my converted DC Modem Pak to a standard telephone line?*

Jason Reighard  
 Toronto, Ohio

**A** The conversion of a DC Modem Pak for use as an RS-232 pack involves removing the 300-bps modem that is part of the DC Modem Pak. After the modification, you must use an external modem (preferably one that operates at higher speeds), connecting it to the converted pack with a standard serial cable (one that sends lines 2 through 8 and Line 20 straight from the DB-25 connector on the pack to the DB-25 connector on the modem). External 1200-bps modems are considered obsolete by many and can be purchased for around \$10 (used) at computer swap meets and flea markets. External 2400-bps modems are quite expensive — about \$70 to \$100 new — and can be had for \$30 to \$50 at swap meets and flea markets.

**Error-Correcting Modems**

*I have a Disto Mini RS-232 pack. I want to know whether or not it can be used with an MNP 5 or V.42bis modem to support hardware flow control.*

Bernie Ruddock (BERSYS)  
 Munville, New Jersey

**A** What is usually needed to support hardware flow control with MNP 5 and V.42bis error detection and compression systems is support for the RTS and CTS lines of the RS-232 port by the hardware of the RS-232 port out, in some cases, by the software that talks to it. The Tandy RS-232 Pak does have hardware support for RTS and CTS. Some of the early Disto Mini RS-232 packs supported RTS and CTS, too. The RS-232 port on Disto's mini-expansion bus, however, does not support RTS and CTS, nor does the CoCoPRO! RS-232 pack (though I did

**A** There is no practical way to convert a printer that has a dedicated Commodore interface. While no doubt a new mother board for the printer would fix the problem, this would cost more than buying a new printer.

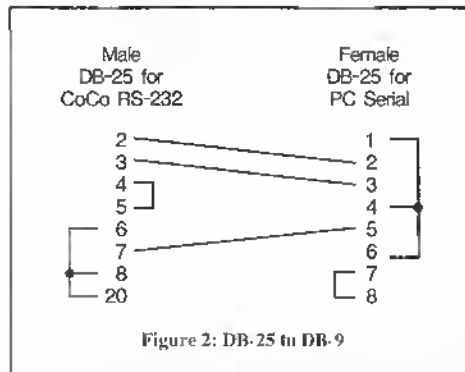

Figure 2: DB-25 to DB-9

You are quite right that better ventilation noticeably improves the heat dissipation of the CoCo, and that most of the heat generated by the CoCo 3 is produced directly below a part of the case that has its ventilation slots “cosmetically” sealed. Opening these slots sounds like an excellent idea, and most certainly is a lot less work than installing a remote power transistor and heat sink.

**Copying the Uncopyable**

*Is there a utility for the CoCo that will allow me to back up copy-protected disks for archival purposes?*

Howard Bacon  
 South Pittsburgh, Pennsylvania

**A** Long ago, Computize offered a utility called Spit 'N Image that could copy most (though not all) copy-protected CoCo disks. Computize has left the market, however, and I don't know if Spit 'N Image is available elsewhere. Alternatively, you can use the Copy 2 PC Option Board on an MS-

provide space on the circuit board to add extra level converters and thus support for RTS and CTS). Check to see if pins 4 and 5 of the DB-25 connector go to a level-converter chip (a MAX232, 1488 or 1489 chip). If those pins are connected to level converters, RTS/CTS hardware flow control can be supported. If those pins are not connected anywhere, RTS and CTS cannot be used for flow control. Note that MNP modems offer an optional use of software flow control, although this may cause problems with binary data.

**Null-Modem Connections**

*About six weeks ago, you gave me information on how to make a null-modem cable to connect my CoCo and 80286-based system. I followed your instructions, but the cable did not work. I got back to you and asked if somehow the problem might be related to the fact that COM 1 and COM 3 share an interrupt (as do COM 2 and COM 4), combined with the*

See CoCo Consultations on Page 26

# SUNDOG SYSTEMS

## PHOTON



Energy is everything, your home world depends on it. However, someone or something is slowly siphoning it away. As your world's champion, you must climb into the experimental Power Tank to challenge this nemesis and his minions. Your key lies with the ability to teleport onto mass. Use this to manipulate and explore the endless stronghold of the enemy, and to exploit the free-floating DUPES (Diverse Units of Photon Energy) to destroy the menacing Plasma Droids. Be cautious, though: these DUPES can be deadly too! Photon, a fantastic new arcade game for your CoCo3, contains spectacular 320x200 resolution, 16 color graphics, ultra-smooth 60 Hz animation, and loads of real-time music and sound effects. It will send your mind racing over endless possibilities, requiring quick decisions and reactions. Quite simply, Photon is incredibly addictive. It will deliver hours of excitement. Will you become your world's greatest hero, or just another energy slave? Req: 128K CoCo 3 and 1 1/4 drive.

**\$34.95**

## GRAPE 2.0 EXPRESS

GRAPE Express is a truly complete graphics and animation programming environment from the beginning to the end. Now, you can use GrapeExpress to create beautiful, fast-appearing graphics and animation, and without any programming background. The GrapeExpress package includes two new,ible, yet sophisticated, tools for creating and editing superb 3D graphics: a ray-tracer (28x192 to 320x225) 6-bit color, 256x128 resolution, from 128x132 to 60x125, 1-bit depth-renderer, and a standard graphics commands (DRAW, LINE, etc.) that blow away the competition. For example, the BOJ command draws 300x1 over 2 MegaBytes/second. It's 300 times faster than BASIC! 256 separate sprites of up to 100x100 pixels each are supplied with window clipping and high-res pixel-level collision checking. The 8-octave, 14-voice music synthesizer has independent envelope, waveform, and volume controls, a 7-bit kHz sampling rate, and much more. Other features include text/graphics mixing, arbitrary font sizes, fast window copying and scrolling, picture save/load, easy implementation from both BASIC and assembly language, multiple screen animation, and support for 128K/512K, double speed, and the high-res joystick interface. The package also contains support programs that are worth the purchase price of GrapeExpress alone! These include an introductory demo, a picture editor, a waveform editor, and an art program that supports 256 colors! GrapeExpress also comes with a 50 page manual that fully explains all of its incredible features - if you do any graphics programming or simply want to see what your little CoCo is capable of, GrapeExpress is a must! Req: 128K CoCo 3 and disk drive.

**\$34.95**

## War Monger



The world is in chaos! Power-hungry villains and evil warlords are eadying their forces. It falls to you to lead your people against these armies, and only your best strategic plans can save the day. Fight the good fight in any era or locale. Play a simple game of capture the flag armed with water balloons, or climb into the cockpit of a 100 foot high armored warter. Explore the deepest dungeons, defend your galaxy, or create your own scenarios with this incredible war game construction set/simulator. Your imagination is your only limit. You will deploy your forces with total control over hostile terrain while you scroll a graphic bird's-eye window over an immense world. War Monger has terrific 320x200 resolution, 16 color graphics and includes a tile editor to create or edit your own. Play against the computer, battle with another player, or simply watch the computer plot against itself. The enemy is everywhere. Are you ready to take on the challenge as the War Monger? Req: 128K CoCo 3 and disk drive.

**\$29.95**

## The Quest for THELDA



An immensely popular 128K CoCo 3 arcade adventure. Over 500 screens of fast fantasy action and puzzle solving. Great graphics and sound effects. \$34.95. Mini book only \$4.95.

## ★ THE ★ CONTRAS

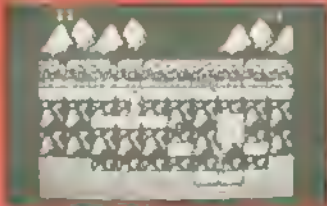

A 512K two player futuristic combat arcade game. Full screen 320x225 hardware scrolling and smooth animation. Back-ground music score and sound effects! 512K CoCo3 only \$34.95. Stripping soon!

## Crystal City



This was the game of 91! Ultra fast space action with hardware scrolling on a 128K CoCo 3. Wild sound effects and pixel 30 MegaBytes of amazing graphics! \$34.95.

## ZENIX



Lightning fast arcade game for the 128K CoCo 3. Terrific 320x225 graphics, back-ground music score and sound effects, and out-of-sight game play. \$29.95.

## ALSO AVAILABLE

Warrior King CoCo 3	\$29.95
In Quest of the Star Lord CoCo 3	\$34.95
Mini Sheet	\$ 3.95
Hell of the King 1, 2 or 3 CoCo 1-3	\$29.95 ea.
Hell of the King Trilogy CoCo 1-3	\$74.95
White Fire of Eternity CoCo 1-3	\$19.95
Dragon Blade CoCo 1-3	\$19.95
Champion CoCo 1-3	\$19.95
Paladin's Legacy CoCo 1-3	\$24.95

Visa, Mastercard, Check, Money Order, and CDD (USA only, please) accepted. All foreign orders must be paid in US currency. Money Order's include \$2.50 for shipping in USA and Canada, \$5.00 Foreign. \$3.00 extra for CDD process. All residents add 6% sales tax. Dealer inquiries welcome. Authors: we're looking for new software!

## Sinistarr



Everyone loves the 512K arcade game 3-D checked with pixel graphics and very background digital sound effects. 512K CoCo 3 only \$34.95.

## KYUUN-SAI TO BE NINJA



The only scrolling 28K CoCo 3 ninjas arcade game now available on 128K CoCo 3. 9 variations. Play like the ninjas, or experience the action from the other side. Perfect for system 128K CoCo 3. \$29.95.



A game in which you can play on a CoCo 3 or your 128K CoCo 3. A 3000-point point-in-time or 1000-point-in-time. With your own 5000 points, you can play on your 128K CoCo 3. \$34.95.



# SUNDOG SYSTEMS

P.O. Box 766 • Manassas, VA 22111  
703/330-8989

# The Card-player's Sort

Sorting a playing hand of cards after they are dealt can be accomplished in several different ways. One method many card players use is as follows: The player starts to form his playing hand by taking the first card from the pile and placing it in one hand. He then picks up the second card, holding it in the empty hand while deciding whether to place the new card on the left side or the right side of the first card. When he picks up the third card, he again holds it in his free hand until he has decided where it should go in relation to the other two. The player continues this process until all the cards in the hand have been sorted to his liking.

This method of sorting cards is equally applicable to sorting data with a computer. The sorting subroutine shown in the listing functions in a manner that is completely analogous to the card player's method for sorting cards. This routine, which is designed to sort 10 numbers stored in an array

under the labels  $X(1)$  through  $X(10)$ , operates entirely within the FOR/NEXT loop between lines 2010 and 2050. The loop variable (A) starts with a value of 2 since there is no need to make a sorting decision until the second number is retrieved (or, for the card player, until the second card is picked up).

In Line 2020, the value of Array Element  $X(A)$  is temporarily stored in  $X(0)$ , which is analogous to the card player's holding the new card in his free hand. In Line 2030, a loop is formed in which the value of  $X(0)$  is sequentially compared to each of the elements that have been processed so far. This loop continues as long as  $X(0)$  has a value that is equal to or greater than the value of the element to which it is being compared. If the value in  $X(0)$  is less than that of the comparison element, the value of that element is passed to the next higher location in the array. This process, which starts with the array element holding the largest value

and progresses toward the one with the smallest value, locates the proper element in the array for storing the new value. This is equivalent to the card player's action of separating his cards one at a time until an opening has been created where the new card should be inserted.

In Line 2040, the value of  $X(0)$  (whose value is equal to the original value of  $X(A)$ ) is stored in the array in its proper location. (This is equivalent to sliding the new card into the opening that has been created for it.) In Line 2050, the program loops back to Line 2020 to process the next element in the array (picking up the next card).

The primary advantage of this sorting technique comes from Line 2030. Note that any array element that is out of place is simply moved to the next highest position in the array. This is accomplished using a single assignment statement,  $X(A+5)=X(A+5-1)$ , and does not require a complete swap of values between two elements in the

array. As a result, the "card-player's sort" uses fewer machine cycles and less processing time than sort routines that perform multiple value swaps between array elements. The average time required to sort 1000 sets of 10 random numbers using a CoCo 3 is about .9 milliseconds. In contrast, the average time to sort 1000 sets of 10 random numbers using an iterative bubble sort is about 1.45 seconds—an increase of more than 60 percent when compared to the time required for the card-player's sort.

In the DEMO program, the FOR/NEXT loop listed between lines 70 and 100 creates a set of 10 random numbers and displays them onscreen. In Line 110, the program branches to the subroutine where the sorting operation is performed. The FOR/NEXT loop, between lines 120 and 140, displays the sorted array in a separate column on the screen, allowing for comparison with the original set of numbers. Because the process of creating and displaying the array values uses a number of additional machine cycles, the total time required to run DEMO ranges from about 1.5 seconds up to as much as 2.0 seconds.

*George R. Mabry is a retired aerospace engineer. He uses his Color Computer primarily for word processing, though on occasion he uses it to develop BASIC programs for use in his consulting work. George can be contacted at 18275 Hvenles Street, Hesperia, CA 92345. Please include an SASE when requesting a reply.*

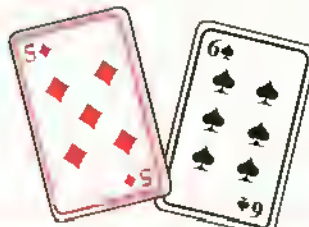
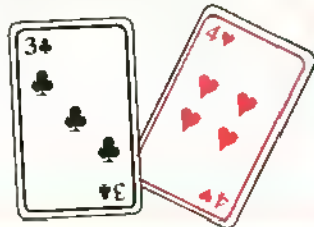

## Feature Program

# Print to the Screen and Printer

Do you ever run BASIC programs that print information onscreen that you really need on paper? Or perhaps you want to keep a paper log of a computing session so you'll know just what you did. In either case, the solution is usually to grab a pencil and paper and start copying. Bah, humbug!

	POKE 360,x	POKE 361,y
Color BASIC	162	130
Extended BASIC	130	115
Disk BASIC 1.0/2.0	203	74
Disk BASIC 1.1/2.1	204	28

Figure 1: Sync Turn-off Pokes

Sync is a simple BASIC program that patches the software in the CoCo so that characters printed on the screen, whether entered from the keyboard or printed by a program, are also sent to the printer. This provides an easy way to keep a log, track moves in an adventure game, or keep a hardcopy of the output from that hot financial program.

The program shown in the listing pokes a short machine-language routine into low memory. This routine traps characters going to the screen and sends a copy to the printer. Two pokes are used (Line 40) to set the CoCo's Console-Out vector to the starting location of the machine-language routine, effectively turning it on.

After you enter the program, double check the data statements and poke values for errors, then save the program to tape or disk. Before running the program, make sure your printer is online; otherwise the computer may "hang." And make sure you use the appropriate baud poke in Line 50 so your printer doesn't print garbage.

(If your printer is set to 600 baud, you can eliminate Line 50 altogether.)

After you run Sync, any characters that appear on the screen are also printed. As written, the program works with any CoCo 1, 2 or 3. It should work with any BASIC program and may work with some commercial products (use the try-and-see method). To stop the synchronous output, hold start on the CoCo; if this isn't acceptable, read on.

Sync is excellent for use as a stand-alone program that allows you to create a printed record of a computing session. Sync can be even more effective when used within your own BASIC creations—you can turn it on when you need it and off when you don't. To add Sync to your BASIC creation, put the lines in the program listing near the beginning of your program. Then you can turn Sync on (using

the pokes shown in Line 40) and off as needed. To turn synchronous output off under software control, use the appropriate pokes from Figure 1. For example, if you have Disk BASIC 1.1, use

```
POKE 360,3:POKE 361,232
```

to turn Sync on and

```
POKE 360,204:POKE 361,28
```

to turn it off. The turn-on pokes are the same for all versions of BASIC and Disk BASIC.

4K

## The Listing: SYNC

```
1 'SYNC
2 'BY JAMES PROVOST
3 'REPRINTED FROM THE MAY 1984
4 'ISSUE OF THE RAINBOW
10 FOR X=1000 TO 1007
20 READ A:POKE X,A
30 NEXT X
40 POKE360,3:POKE361,232
50 POKE150,1 'PRINTER BAUD POKE
60 DATA 52, 84, 109, 162, 191
70 DATA 53, 84, 57
```

4K

## The Listing: CAROSORT

```
1 'CARD-PLAYER'S SORT DEMO
2 'BY GEORGE R. MABRY
3 'COPYRIGHT (C) 1992
4 'BY FALSOFT, INC.
5 'RATNBOW
40 CLS
50 PRINT "CARD PLAYER'S SORT PRO
GRAM"
60 PRINT
70 FOR A=1 TO 10
80 X(A)=RND(T000)
90 PRINT X(A)
100 NEXT A
110 GOSUB 2000
120 FOR A=1 TO 10
130 PRINT @(32*A+40),X(A)
140 NEXT A
150 PRINT
160 PRINT "RUN THE PROGRAM AGAIN"
"
170 PRINT "Y OR N?"
180 Z$=INKEY$:IF Z$="" THEN 180
190 IF Z$="Y" THEN 40
200 IF Z$<>"N" THEN 180
210 END
2000 REM* CARD PLAYER'S SORT *
2010 FOR A=2 TO 10
2020 S=0:X(0)=X(A)
2030 IF X(0)<X(A+5-1) THEN X(A+S)
=X(A+5-1):S=S+1:IF (A+S)>1 THEN
2030
2040 X(A+S)=X(0)
2050 NEXT A
2060 RETURN
```



# Proven Technology

On the Razor's Edge of the Color Computer Frontier

**OWL Phones**  
 Order Numbers (only)  
 1-800-245-8228  
 1-215-682-6855  
 Fax: 1-215-837-1942  
 Technical Help  
 1-215-837-1917

In our 10<sup>th</sup> Year!

A DECADE OF SERVICE TO THE COMPUTER USER!

## 486SX-20 SYSTEMS - \$1795.00!

Now You can enter the world of 486 computing at a reasonable cost!

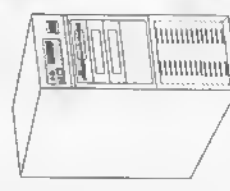

### the OWL SUPER ATOM - 486

High Powered Computing from a local, well established company.

- 33MHz / 60MHz 1488 based System with Socket for Witek Co-Processor
- System and Video BIOS in Cache
- Large Tower Case (33MHz, FCC Class B) - (60MHz, FCC Class A)
- 250 Watt Power Supply & 8 Option Slots
- System Price Includes: 40MB HD, 4MB RAM, Std. Resolution Color VGA Monitor, High Resolution VGA Card, 2 High Density FD's, MS DOS 5.0

**\$1795 / \$2095 / \$2695 / \$3595**  
 486SX-20 ISA    486DX-33 ISA    486DX-50 ISA    486DX-50 EISA

**3-YEAR WARRANTY** on all systems!  
 Including One Full Year on Drive and Lobby  
 Manufactures 3-Year Warranty on All Hard Drives

### OWL SUPER ATOM - 386

- 25/40MHz 386DX Based
- Small Footprint Case
- FCC Class B Approved
- 200 Watt Power Supply
- 7 Expansion Slots
- 4MB of RAM
- 40MB Hard Drive
- Std. Resolution VGA Color Monitor
- 2 High Density FD's
- 101 Keyboard
- MS DOS 5.0

**\$1565/\$1645**  
 25MHz    40MHz

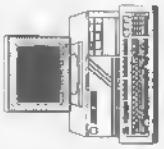

### OWL SUPER ATOM - SX

- 16/25MHz 386SX Based
- Small Footprint Case
- FCC Class B Approved
- 200 Watt Power Supply
- 7 Expansion Slots
- 2MB of RAM
- 40MB Hard Drive
- Std. Resolution VGA Color Monitor
- 2 High Density FD's
- 101 Keyboard
- MS DOS 5.0

**\$1295/\$1349**  
 16MHz    25MHz

### 386-SX Notebook Computers

20MHz, 60MB HD, 2MB RAM (exp. to 5MB), VGA 640x480 LCD w/32 shades of gray, Ports: 2 Ser. 1 Par, 1 VGA, DOS & Windows. 7.7LBS!  
**\$1545**

### 386-DX Notebook Computers

33MHz, 120MB HD, 1.44MB FD, 32KB CACHE, 4MB RAM (exp. to 16MB), Std. VGA LCD w/32 gray. Ext. Keypad inc., DOS & Windows. 7.7LBS!  
**\$1995**

## OWL COMPUTER SERVICES

5950 Keystone Drive  
 Bath, PA (215)-837-1917

**Us & Us - RadioShack®**  
 Pottstown Ave. RT. 663  
 Pottstown (215)-679-3389

**St. Onge Systems**  
 Westcoast  
 Call for Appl. (215)-481-9775

**Computers & Games**  
 Multitenet Shopping Plaza  
 Reading (215)-929-0540

# DISK DRIVES

## Floppy Drive Systems

The Highest Quality for Years of Service

Drive 0 Systems (Half Height, Double Sided,

~~\$180~~

WE NEED CONTROLLERS!

IF YOU HAVE 502 CONTROLLERS, CALL US!

Drive 1 Systems (Half Height, Double Sided,

Direct Drives) **\$115.**

New 3.5", 720K Drives for OS-9 with case

& Power Supply **\$129. SALE!**

Drive 1 Systems have drive, case, power supply. (You may require optional cable and/or DOS chip to use)

Special for 0/1 Combos (0,1,2,3) **\$199.**

(WITHOUT CONTROLLER)

### HALF-HEIGHT DRIVE UPGRADES FOR RS HORIZONTAL CASES

Why only double the capacity of your system when you can triple in the same case? Kit includes: double-sided to fit your case, chip to run both sides of new drive, hardware, and detailed instructions. Easy! Takes only 5 minutes!

Model **Only \$119.**  
 500, 501, or 502

Drives 1 Year Warranty

### OWL WARE Software Bundle

#### Disk Tutorial/Utilities/Games DISK TUTOR Ver 1.1

Learn how to use your disk drive from this multi-lesson, machine language program. This tutor takes you through your lessons and corrects your mistakes for a quick, painless disk drive introduction. (This professionally written tutor is easily worth the bundle's total price.)

#### 3 UTILITIES

A copy verify, copy, and DOS utility.

#### 2 GAMES

We will select 2 games from our stock. These are sold for more than \$20 each.

Do not mistake this software with cheap "Public Domain" software which others offer. All of this software is copyrighted and professional in quality. The tutor is unique with us and has helped thousands of new users learn their disk drive.

only **\$27.95**

(or even better)

only **\$6.95** with any Disk Drive Purchase!

### 512K Upgrade

Again at a popular price. Fully assembled and tested before shipping. Easy to install. Uses fast 120 ns chips.

**SALE \$79**

Now includes memory test, Ram Disk Lighting, Printer Lighting, and Back-up Lighting. All with an upgraded manual exclusive with OWL!

Our prices include a discount for cash but do not include shipping.

OWL-WARE has a liberal warranty policy. During the warranty period, all defective items will be repaired or replaced at no cost to the buyer except for shipping costs. Our "tech number" for repairs is 1-215-837-1917. We do not charge extra for parts or labor in a worst case change.

### OWL-WARE

P.O. BOX 116  
 Mertztown, PA 19539

Feature Program

# Pretty-print OS-9 Source Code

Programmers are notorious for taking the easiest path to finish a task. For example, the OS-9 assembler allows you to print several spaces between fields (label, mnemonic, operand and comment) to align the columns, making the assembly-language listing very easy to read. (Notice how neat the listings look in THE RAINBOW.) However, if you're like me, you take the shortcut and put only one space between the fields. The problem with this is that when you print the listing for debugging or to show to someone, all the fields run together and it is downright difficult to read.

Pretty is a machine-language program I wrote to solve this problem. Pretty formats the source code and makes it look like it came straight from the pages of THE RAINBOW — and you can continue to put only one space between fields.

To use the program, just enter pretty followed by the name or path of the desired file. If you omit the source filename, the program accepts lines from the standard input path through a pipeline or by input redirection. Two examples of this are

```
llst sourcefile ! pretty
```

and

```
pretty <sourcefile
```

Pretty sends the newly formatted source

code to the standard output path, so it can be viewed on the screen or redirected to the printer or to a file. For example,

```
pretty nglysource >prettysource
```

formats the source code in ugly source and saves it in a new file called prettysource.

The -p option tells the program to paginate the output. If used, Pretty prints 65 lines then a blank line to ensure the printer skips over the fanfold perforations. To have Pretty do this, just enter -p directly after pretty on the command line. To alter the line and page lengths, change the equate (equ) statements in the listing before assembling the program.

The assembly-language source code for Pretty is shown in Listing 1. If you do not have an OS-9 assembler, enter and run the BASIC09 program shown in Listing 2. This program generates the executable pretty module and stores it in the CMDS directory on the default drive. Level 1 users need to change all references to /dd in Listing 2 to /d0 (or another appropriate drive).

*Stephen Goldberg is a dentist and the author of the Utilipak series of OS-9 utilities. He can be contacted at 695 Plainview Road, Bethpage, NY 11714. Please include an SASE when requesting a reply.*

OS-9

Listing 1: Pretty.esm

```
*****
* PRETTY - (c) 1988 by STEPHEN B. GOLDBERG
*
* Use: pretty [-p] [file]
* Formats and optionally paginates assembly language
* source code to standard output path. The standard
* input path is used if file name is omitted.
*
        ifpl
        use    /dd/defs/os9defs
        endc
*
        mod    len.name.prgm+object.reent+1.entry.dsiz
*
linelen equ    80           printer line length
pagelen equ    66           page length
*
path     rmb    1           input path number
string   rmb    1           string flag
delim    rmb    1           string delimiter
paginate rmb    1           pagination flag
pgcount  rmb    1           text line counter
inbuff   rmb    255        input buffer
outbuff  rmb    255        output buffer
         rmb    200         stack
         rmb    200         parameters
dslz     equ    .
*
name     fcs    /Pretty/
         fcb    2           editlon number
         fcc    /(c)1988 S.B.Goldberg/
*****
* INITIALIZE AND OPEN FILE
*****
entry   clr    peth          stenderd input peth
        clr    string       clear string flag
        clr    peginete     clear pagination flag
        decb  parameter?   parameter?
        beq   newpage       no, use stenderd input
        ldd   ,x            parameter characters
        cmpe  #'           option?
```

```

        bne   open          no, open file
        orb   #$20         make lower case
        cmpb  #'p          paginete?
        bne   open          no, open file with error
        inc   paginate     yes, set page flag
        leex  1,x         bump pointer
findfile ldd   ,x+         parameter characters
        cmpb  #$20         filename?
        beq   findfile     no, look some more
        blo   newpage      no filename, use standard input
open     lde   $reed       read mode
        os9   l$open       open input file
        bcs   pass         exit with error
        ste   peth         save peth number
*****
* GET LINE FROM INPUT
*****
newpage lda   #pagelen-1  lines/page
        ste   pgcount      to line counter
getline lda   path         input path number
        leex  inbuff,u     input buffer
        ldy  #255         maximum line length
        os9   l$reedln     get line
pass     lbc   error       branch on error
        lda   ,x           first character
        cmpa  #$0d         blank line?
        beq   printit      yes, print lt
        cmpe  #'          comment?
printit  lbeq  print2      yes, print it
*****
* FORMAT FIELD COLUMNS
*****
        leay  outbuff,u    output buffer
        ldb  #8            length of label field
        bsr  movetext      move label to output buffer
        pshs y             save register
        ldb  #3            opcode length
        leay fcc,pcr       string pseudo-op
        bsr  compare       expect string operand?
        bcc  setflag       yes, set string flag
        bsr  compare       expect string?
        bcc  setflag       yes, set string flag
        bsr  compare       inherent mode opcode?
        bcs  chknext       no, check next opcode
        puls y             yes, retrieve register
        ldb  #20           opcode + blank operand
        bra  operand       move both
chknext  tst   ,y          check next opcode character
        beq  opcode        done, move opcode
        bpl  chkmode       good opcode, check lt
        incb 1             no good, check 4 character opcodes
        leay 1,y          bump pointer
        bra  chkmode       check opcode
*
compare  os9   f$cmpnam    compare opcodes
        leay  b,y         next opcode
        rts
*
setflag  inc   string      set string flag
opcode   puls  y           retrieve register
        ldb  #5           opcode field length
        bsr  movetext      opcode to output buffer
        ldb  #14          operand field length
        tst  string        string field?
        beq  operand       no, move operand to output buffer
        bsr  dostring      yes, ignore spaces in string
        bra  document      add comment
operand  bsr  movetext     operand to output buffer
document clre             no delimiter
        bsr  comment      add comment to output buffer
*****
* MOVE FIELD TO OUTPUT BUFFER
*****
movetext lda   ,x+         line character
        cmpa  #$20         space?
        beq  skip          yes, add spaces to buffer
        sta  ,y+          no, to output buffer
        cmpe  #$0d         end of line?
        beq  print        yes, print line
        decb 1            no, count character
        bra  movetext     move another character
skip     lde   ,x+         line character
        cmpe  #$20         another column?
        beq  skip         no, check again
        blo  movelt       end of line, save and print
        leex -1,x         reset pointer for next column
        lde  #$20         space
        sta  ,y+         to buffer
        decb 1            end of column?
```

```

bp1 spacer          eo, add another space
rts                return
*
dostring lda ,x+      first string character
sta ,y+            to buffer
comment sta dellm    save as delimiter
decb          count character
bra checkend       check for end of line
mvstring  lda ,x+    string character
sta ,y+            to buffer
decb          count character
cmpa dellm        end of string?
beq skip         yes, space to next column
checkend cmpa $f0d  end of line?
beq print        yes, print line
bra mvstring      no, move another character
    
```

\*\*\*\*\*  
 \* PRINT AND CHECK FOR PAGE END  
 \*\*\*\*\*

```

print leas 2,s      reset stack
clr string        clear string flag
leax outbuff,u    output buffer
print2 ldy $llnlen maximum line length
lda $l            standard output
os9 l$writln      line to output
bcs out          exit with error
tst paginate      pages?
lbeq getlline     no, get next line
dec pgcount       end of page?
lbne getline      no, get next line
leax <cr,pcr      yes, carriage return
ldy $l            one character
os9 l$writln      carriage return to output
lbra newpage      start new page
    
```

\*\*\*\*\*  
 \* ERROR CHECK AND EXIT  
 \*\*\*\*\*

```

error  cmpb $e$eof  end of file?
       bne out       quit with other error
noerr  clrb         clear error flag
out    os9 f$exit   quit
*
cr     fcb $0d      carriage return
fcc   fcs /fcc/    string pseudo-op
fcs   fcs /fcs/    string pseudo-op
    
```

\*\*\*\*\*  
 \* INHERENT MODE OPCODES  
 \*\*\*\*\*

```

fcs /abx/
fcs /daa/
fcs /mul/
fcs /nop/
fcs /rft/
fcs /rts/
fcs /sex/
fcs /swl/
fcs /asla/
fcs /aslb/
fcs /asra/
fcs /asrb/
fcs /clra/
fcs /clrb/
fcs /coma/
fcs /comb/
fcs /cwai/
fcs /deca/
fcs /decb/
fcs /lnca/
fcs /lncb/
fcs /lsla/
fcs /lslb/
fcs /lsra/
fcs /lsrb/
fcs /nega/
fcs /negb/
fcs /rola/
fcs /rolb/
fcs /rora/
fcs /rorb/
fcs /swi2/
fcs /swi3/
fcs /sync/
fcs /tsta/
fcs /tstb/
fcb 0
*
ten  emod
     equ *
     end
    
```

**Listing 2: Makepretty.b09**

```

PROCEDURE Makepretty
0000 (* Generates the binary module pretty *)
0020 (* Level 1 - change all /dd to /d0 *)
0040 DIM path,byt:BYTE
0050 DIM count:INTEGER
005E PRINT "Creating pretty . . ."
0079 CREATE #path,"/dd/cmds/pretty":WRITE
0093 FDR count-1 TO 443
00A4 READ byt
00A9 PUT #path,byt
00B3 NEXT count
00BE CLOSE #path
00C4 PRINT
00C6 SHELL "attr /dd/cmds/pretty e pe"
00E3 END
00E5 DATA 135,205,1,187,0,13,17,129,146,0,40,3,147,80,114,101
0119 DATA 116,116,249,2,40,99,41,49,57,56,56,32,83,46,66,46,71
0150 DATA 111,108,100,98,101,114,103,15,0,15,1,15,3,90,39,33
0184 DATA 236,132,129,45,38,18,202,32,193,112,38,12,12,3,48,1
    
```



**Burke & Burke**  
 P.O. Box 733 Maple Valley, WA 98038  
 U.S. ORDER DESK: (800) 237-2409  
 INT'L & TECHNICAL: (206) 432-1814

See you at  
 CoCo Fest  
 '92!

**RUN OS9 LEVEL 2 VISIBLY FASTER - GET A \$29.95 POWERBOOST FROM BURKE & BURKE!**

You can see the difference in OS9 Level 2 when you install the PowerBoost kit from Burke & Burke. It includes the amazing Hitachi HD63B09E microprocessor, a 100% compatible high-performance replacement for your CoCo 3' MC68B09E. Using the HD63B09E's added registers and high-speed instruction set, block moves and other functions are up to 4x as fast! The PowerBoost kit includes Burke & Burke's PowerBoost software, which modifies your OS9 Level 2 operating system for faster multi-tasking, graphics, and disk I/O when using the HD63B09E. SOLDERING IS REQUIRED TO INSTALL THE HD63B09E.

*PowerBoost (HD63B09E w/ Software for OS9) \$29.95*

The 6309 Book by Chris Burke. This book describes the instruction set of the HD63B09E microprocessor, and gives assembly language examples that help you detect the high-performance processor and take advantage of its capabilities in your programs. Includes disk with OS9 Assembler / Disassembler / Debugger patches for HD63B09E. REQUIRED 'ASM' ASSEMBLER, 'DEBUG' DEBUGGER, AND HD63B09E MICROPROCESSOR NOT INCLUDED.

*The 6309 Book (Includes disk with development tools for OS9) \$24.95*

---

*WORLD CLASS CHESS\* - Use Cyrus Chess w/ Level 2 \$29.95*  
*FILE SYSTEM REPACK 1.1 - Faster disk defragmenter \$29.95*  
*R S B.\* - Disk BASIC for Level 2 (BASIC ROM required) \$39.95*  
*EZGEN 1.09 - Handy & powerful OS9 bootfile editor \$19.95*  
*ZCLOCK - Continuous time / date display on Level 2 screen \$9.95*  
*COCO XT - Use PC hard drive w/ CoCo! OS9.S/W incl \$69.95*  
*(Add \$30 for Real-Time Clock. Add \$20 for auto boot ROM)*

WA RESIDENTS ADD 8.2% SALES TAX. MasterCard & VISA accepted. U.S. COD's add \$3.75. Min. U.S. shipping \$4.00. Min. to Canada \$5.00. Please allow 2 weeks for delivery. Overnight or 2nd-day available for in-stock items. Software upgrades \$5.00 each w/receipt, including U.S. shipping.  
 Call or write for a free catalog of more exciting Color Computer products!

## GRANITE COMPUTER SYSTEMS

### ZOOM MODEMS

**NEW! 14,400 BPS ZOOM V.32bis/V.42/V.42bis data modems.** MNP1-5+LAPM. Error Correction and data compression (much higher effective throughput — as much as 57,600 BPS). Two Year Warranty. External \$339/Internal \$299 (+\$9 S&H)

**NEW LOWER PRICE! 9600 BPS ZOOM V.32/V.42/V.42bis data modems.** MNP1-5+LAPM. Error Correction and data compression (much higher effective throughput — as much as 38400 BPS). Two Year Warranty. External \$299/Internal \$279 (+\$9 S&H)

**NEW LOWER PRICE! 2400 BPS ZOOM V.42/V.42bis data modems.** MNP1-5+LAPM. Error correction and data compression (much higher effective throughput — as much as 9600 BPS). Two Year Warranty. External \$149 (+\$9 S&H)

**NEW PRODUCT! 9600 BPS ZOOM Send/Receive Fax modems.** Send/Receive text/graphics files from/to your computer/any fax machine in the world. Full 2400 BPS data modem capability. Seven Year Warranty. Includes PC or MAC FAX software. External \$139/Internal \$129 (+\$6 S&H)

**NEW LOWER PRICE! 2400 BPS ZOOM Data modems.** Seven Year Warranty External \$85/Internal \$75 (+\$6 S&H)

These are all high quality modems made by Zoom Telephonics in the USA. Fully Hayes compatible. Terminal and Windows Fax software available. Cables available. S&H Canada (Air PP and Ins): V.32, V.42/V.42bis \$13.00 Send/Receive Fax/Data \$9.00

### GCS FILE TRANSFER UTILITIES — Version 3.0

The GCS File Transfer Utilities provide a simple and quick method to transfer text/binary files from/to a variety of floppy disk formats.

**Commands** PC, RS, FLEX disks: Dir, Dump, Read, Write  
 PC disks: Rename, Delete, Format

Handles most 5.25 and 3.5 formats. Any level sub-directories (PC). Binary files. Use pipes for multiple file transfers. Multi-Vue version can be used under Multi-Vue or as stand alone Shell commands.

Requires OS-9 L2 for COCO 3, L1 for COCO 1 or 2. 2 drives (one can be hard/disk, one floppy 40 T OD DS). Multi-Vue for Multi-Vue version. SDISK3 for COCO3 - SDISK for COCO 1 or 2.

OSK version price	\$99.95
Multi-Vue version	\$54.95 Standard version \$44.95
V3.0 updates (provide disk number)	\$25.00/\$15.00

D.P. Johnson Software SDISK or SDISK3 \$29.95 L1+L2 Utils \$75.00  
 Shipping and handling — any software \$2.50 U.S.A., \$3.00 Canada  
 Orders must be prepaid or COD. VISA/MC accepted. COD is additional.

**571 Center Road, Hillsboro, NH 03244 USA**  
**(603) 464-3850**

OS-9 is a trademark of Microsoft Systems Corporation and Motorola, Inc.  
 MS-DOS is a trademark of Microsoft Corp. FLEX is a trademark of TSC, Inc.

0188	DATA 236,128,193,32,39,250,37,9,134,1,16,63,132,37,17,151	04A2	DATA 6,13,102,99,227,102,99,243,97,98,248,100,97,225,109
01EC	DATA 0,134,66,151,4,150,0,48,69,16,142,0,255,16,63,139,16	04D3	DATA 117,236,110,111,240,114,116,233,114,116,243,115,101
0223	DATA 37,0,187,166,132,129,13,39,2,129,42,16,39,0,139,49	04EE	DATA 248,115,119,233,97,115,108,225,97,115,108,226,97,115
0257	DATA 201,1,4,198,8,141,66,52,32,198,3,49,141,0,168,141,27	052C	DATA 114,225,97,115,114,226,99,108,114,225,99,108,114,226
028E	DATA 36,31,141,23,36,27,141,19,37,6,53,32,198,20,32,35,109	055A	DATA 99,111,109,225,99,111,109,226,99,119,97,233,100,101
02C6	DATA 164,39,15,42,240,92,49,33,32,235,16,63,17,49,165,57	0588	DATA 99,225,100,101,99,226,105,110,99,225,105,110,99,226
02F9	DATA 12,1,53,32,198,5,141,15,198,14,13,1,39,4,141,40,32	058E	DATA 108,115,108,226,108,115,108,226,108,115,114,225,108
0330	DATA 2,141,3,79,141,37,166,128,129,32,39,9,167,160,129,13	05E1	DATA 115,114,226,110,101,103,225,110,101,103,226,114,111
0364	DATA 39,45,90,32,241,166,128,129,32,39,250,37,239,48,31	060C	DATA 108,225,114,111,108,226,114,111,114,225,114,111,114
0395	DATA 134,32,167,160,90,42,251,57,166,128,167,160,151,2,90	0637	DATA 226,115,119,105,176,115,119,105,179,115,121,110,227
03C6	DATA 32,9,166,128,167,160,90,145,2,39,220,129,13,39,2,32	0662	DATA 116,115,116,225,116,115,116,226,0,31,1,214
03FA	DATA 241,50,98,15,1,48,201,1,4,16,142,0,89,134,1,16,63,140		
0434	DATA 37,30,13,3,16,39,255,73,10,4,16,38,255,67,48,140,18		
0468	DATA 16,142,0,1,16,63,140,22,255,50,193,211,38,1,95,16,63		

Quickie Hardware Project

# Pause Switch Adds Freedom to CoCo Habits

Ring... Ring...  
 "Could you get that, Tom? I'm playing *Reactoids*."  
 "It's for you Jeff."  
 "But I've almost beat my high score, and I have three reflectors left."  
 "He says it's important."  
 "Coming. &!@%S!!!"

A common scenario in your home? I wish all games had a built-in pause feature, but some don't. Fortunately I came up with a solution.

**You can use the switch to pause any program or to keep other people from messing up any program currently in your computer.**

While reading through the service manual for my CoCo, I came across a reference to a \*HALT line, a special control line on the 6809 CPU (central processing unit) chip. This line is available at Pin 40 on the 6809 and goes directly to Pin 3 on the Color

Computer's cartridge port. The \*HALT line is active-Low (hence the asterisk), which means it is normally tied High through a resistor and is activated by "pulling" the line Low. This is done by connecting it to ground.

As soon as the 6809 detects a Low state on the \*HALT line, it finishes the instruction currently being executed and waits for the \*HALT line to go High again. We can use this feature to our advantage. If we connect a switch between the \*HALT line and ground, we have created a hardware "pause" switch. And it works with any program: BASIC, machine language or ROM cartridge. However, it is important to remember you should *not* use the new pause switch when input/output equipment (disk drives, tape recorders, printers or modems) is in operation.

To add a pause switch to your CoCo, you'll need an SPST (single-pole, single-throw) switch, two 1-foot lengths of insulated wire, a soldering iron and solder, and a phillips screwdriver. You can find the switch at any Radio Shack or local electronics outlet. If you have no experience using a soldering iron, find a friend who does.

Now make sure the CoCo is *not* plugged in, then turn it on to drain any remaining charge in the main capacitor. This helps to protect you as well as the computer. You should also eliminate any static charge in your body by touching a grounded metal object (the cold-water pipe in your home should do the trick).

Now turn the CoCo on its back and remove the six screws holding the case bottom to the case top. (Note that doing this voids any existing warranty on the computer.) Turn the CoCo back over and remove the top of the case,

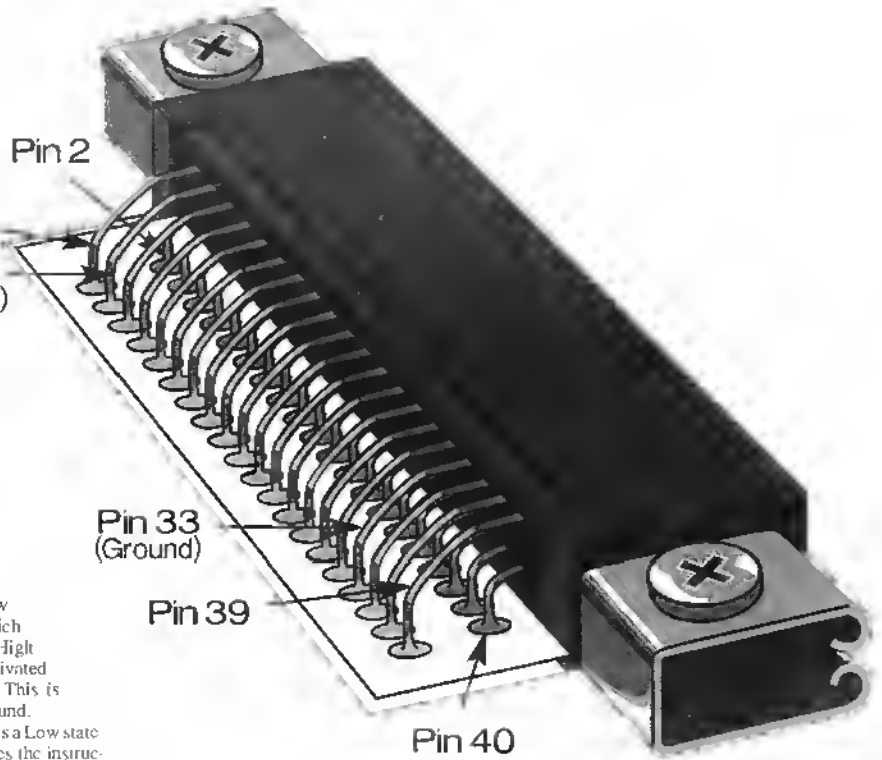

Look at the right side of the computer and you will see two rows of 20 metal pins connecting the cartridge slot to the main circuit board (see Figure 1). The pins in the *left* row are numbered 1, 3, 5, 7 and so on, from top to bottom (from the back of the computer to the front). Similarly, the pins in the *right* row are labeled 2, 4, 6, 8 and so on, from top to bottom.

As I stated before, the \*HALT line is connected to Pin 3, the second Pin from the back in the left row. Signal ground is available on pins 33 and 34 of the cartridge connector. We are going to connect the switch between these two signals. Since Pin 33 is the easiest ground pin to reach with a soldering iron, we'll use that one.

Now you need to decide where and how you want to mount the switch. I cut a small square hole just above the cartridge port. The case is pretty tough so I had to use a hammer and a very sharp chisel. If the switch you purchase is designed to fit a round hole, use a power drill to make the opening. If you don't want to risk hurting the CoCo (or yourself), you may want to simply have the wires come up through the vents on top of the CoCo, making sure to knot the wires inside the case so they won't be yanked out. However, make sure you

install the switch connections with electrical tape.

Once the switch is mounted, use the soldering iron to solder a piece of wire to each of the two connectors on the SPST switch. Then solder one of these wires to Pin 3 of the cartridge connector and the other to Pin 33. Be careful not to drip any solder on the circuit board. If you do, wait a few seconds for it to cool, then *carefully* push it off the board with a small screwdriver or a pencil.

After you finish soldering and make sure the connections are secure, put the top back on the CoCo and replace the six screws. Now you can use the switch to pause any program or to keep other people from messing up any program currently in your computer. Happy pausing!

*Jeff Swidl majored in computer science and minored in math, music and French. He plans to pursue a doctorate in computer engineering. Jeff enjoys pushing the CoCo 3 to new limits and is the author of the Sindog Systems' products GrafExpress and Photon.*

Feature Program

# Two Players for the Price of One

**S**tar Grabber is a short two-player game in which both players try to "grab" as many stars as they can. The program requires two joysticks.

To gather stars, a player moves the right or left joystick to control a colored circle on the screen. The circle controlled by the right joystick is blue, and the left joystick controls the orange circle. Once a star is centered in the circle, its color changes to match that player's color. At the end of two minutes, the player who has gathered the most stars is the winner.

Star Grabber requires 16K Extended BASIC and is designed to be as short as possible to demonstrate the power of the language. (It also cuts down on typing time — you can start to enjoy the game more quickly.) I was careful to trim the program size and use every trick I could to increase execution speed. For instance, all variables use single-letter variable names. In addition, all the lines were packed as tightly as possible. If you have a CoCo 3, you can double the speed using the high-speed poke (POKE 65497,0). However, make sure you slow the computer down (POKE 65496,0) before saving or loading any programs.

The most complex part of Star Grabber is the built-in machine-language routine

used to tally the final score. This is the only area where BASIC was unable to provide the desired speed.

Note to users with 16K machines: As written, Star Grabber assumes the Color Computer has 32K. If the disk drive is connected, you must have 32K before Star Grabber will run. To move the machine-language routine to a location suitable for 16K machines, make the following changes:

Line	Change	To
40	32591	16207
40	32592	16208
100	32592	16208
100	32651	16267
100	32653	16269

*Jim McDowell has worked with the Color Computer for the past 10 years. He has written several articles for the CoCo and continues to produce programs under the business name JML Software Design. He can be contacted at 34 Mair Street, Colchester, VT 05446-1155. Please include an SASE when requesting a reply.*



# Do You Rest Easy at Night?



THE RAINBOW is the only publication that offers peace of mind to CoCo users. Members of the CoCo Community have always looked to THE RAINBOW for comfort — hints, tips, the latest news and communication with others — for their Tandy Color Computers.

THE RAINBOW continues to serve and support CoCo users, from beginners to the advanced, by covering the wide variety of topics affecting the CoCo Community. Looking for games? Telecommunications packages? Finance programs? Interested in helpful utilities? Hands-on hardware projects? Want to take the guesswork out of buying software and hardware? From Disk BASIC to OS-9, THE RAINBOW has the answers to all your CoCo questions.

Get rid of your nightmares by renewing your subscription today. THE RAINBOW — the best security blanket for a good night's rest.

### Use our 800 number!

For credit card orders, you may phone in your subscription. Our credit card order number is (800) 847-0309, 9 a.m. to 5 p.m. EST. We accept VISA, MasterCard and American Express. All other inquiries call (502) 228-4492.

### Yes! Please send me RAINBOW Magazine.

- Choose one:  New  Renew (attach label)
- One Year \$31 — 35% off cover price
  - Two Year \$58 — 39% off cover price
  - One Year \$79 — 44% off cover price

Which Tandy Color Computer do you use?  
 CoCo 1  CoCo 2  CoCo 3

Name \_\_\_\_\_  
 Address \_\_\_\_\_  
 City \_\_\_\_\_ State \_\_\_\_\_ ZIP \_\_\_\_\_  
 My check in the amount of \_\_\_\_\_ is enclosed.  
 Charge to:  VISA  MasterCard  American Express  
 Account Number \_\_\_\_\_  
 Expiration Date \_\_\_\_\_ Signature \_\_\_\_\_

Subscriptions to THE RAINBOW are \$31 a year in the United States. Canadian rate is \$38 plus 7% GST (U.S. funds only). Surface rate elsewhere is \$68 (U.S.). Non-U.S. subscribers must inquire about multi-year discount. Airmail is \$103 (U.S.). Kentucky residents add 6% sales tax. All subscriptions begin with the current issue. Please allow 6 to 8 weeks for the first copy. In order to hold down non-editorial costs, we do not bill.

For credit card orders, call (800) 847-0309, 9 a.m. to 5 p.m. EST. All other inquiries call (502) 228-4492.

# RELIEF



## Save Money Too!

Subscribe to these convenient services and receive each month's programs in a ready-to-run form. No more long tedious hours wasted typing! No more red eyes and sore fingers! All you do is load and run, using the current issue of THE RAINBOW as documentation.

OS-9 programs are available too! One side of the RAINBOW ON DISK is formatted for the OS-9 operating system (OS-9 programs cannot be put on tape) so you can get all the great programs in the magazine.

A one-year subscription to THE RAINBOW and RAINBOW ON TAPE is only \$91 in the U.S., \$108 in Canada, \$153 foreign surface rate and \$188 foreign airmail.

A one-year subscription to THE RAINBOW and RAINBOW ON DISK is only \$115 in the U.S., \$138 in Canada, \$183 foreign surface rate and \$218 foreign airmail. U.S. currency only. Back issues of both RAINBOW ON TAPE and RAINBOW ON DISK are also available! (see our back issue ad in this issue)

RAINBOW ON TAPE back issues are available beginning with the April 1982 issue. A single copy of RAINBOW ON TAPE is \$10 within the U.S., \$12 in all other countries. The annual subscription for RAINBOW ON TAPE is \$80 within the U.S.; \$90 in Canada; and \$105 for all other countries. U.S. currency only.

RAINBOW ON DISK back issues are available beginning with the October 1986 issue. A single copy of RAINBOW ON DISK is \$12 within the U.S., \$16 in all other countries. The annual subscription for RAINBOW ON DISK is \$99 within the U.S.; \$115 in Canada; and \$130 for all other countries. U.S. currency only.

**Yes! Sign me up for a joint 1-year subscription (12 issues) to:**

- THE RAINBOW and Rainbow on Tape
- THE RAINBOW and Rainbow on Disk
- New
- Renewal (attach labels)

Name \_\_\_\_\_

Address \_\_\_\_\_

City \_\_\_\_\_

State \_\_\_\_\_ Zip \_\_\_\_\_

My check in the amount of \_\_\_\_\_ is enclosed.

Charge to:  VISA  MasterCard  American Express

Account Number \_\_\_\_\_

Expiration Date \_\_\_\_\_ Signature \_\_\_\_\_

For credit card orders, call (800) 847-0399, 9 a.m. to 5 p.m. EST. All other inquiries call (502) 228-4492.

\* Payment must accompany order; we do not bill. U.S. currency only, please. Kentucky residents add 6% sales tax; Canadian residents, 7% GST. Please allow 6 to 8 weeks for delivery of first copies. All subscriptions begin with the current issue.

Please note: While group purchases of RAINBOW ON TAPE and RAINBOW ON DISK are permitted (and multiple subscriptions are even discounted if purchased in one order from a club), no license to make copies is conveyed or implied. Unauthorized copying of any copyright product is strictly illegal.

### Quickie Program

# Turn the World On End

Bring together Bill Romano's *World* (THE RAINBOW, September 1988, Page 70), Fred Crawford's cover for the November 1987 telecommunications issue and an opening scene from Stanley Kibrick's *2001*, and you are *In Orbit*. *In Orbit* is a short BASIC program that is really out of this world (or off the planet, anyway).

Enter the program and save it to tape or disk before running it. Some of the lines in the listing are "packed" — these lines contain a few more characters than the CoCo normally allows you to enter. To enter these lines, type all the characters you can until the cursor won't move any farther. Press ENTER, then enter EDIT line, where line is the line number you are entering. Press X (for extend) and the cursor moves to the end of the line, at which point you can enter the remaining characters. Then just press ENTER to save the edited line in the CoCo's memory.

*In Orbit* draws a world map, then rotates it around the screen while playing a little something written by Strans. Of course, you could substitute one of your own favorite screens for the image drawn in lines 110 through 160, and put a different 32-bar waltz in the PLAY values in Line 100 — but the effect would not be the same.

The high scroll rate is a result of my unique use of PCOPY in Line 190. (The GET and PUT commands reposition only 2/3 of the screen.) It should be easy to extend this

technique for use with graphics modes other than PMODE 1.

I hope you enjoy this little graphics/sound diversion. And I hope you will take the time to learn new animation tricks and techniques.

*After careers in aerospace, mechanical and structural engineering, Barry Mitchell is exploring the computer-aided varieties. His outlets are tennis, biking, swimming and climbing with his family, and pushing the limits of his CoCo 3. He can be contacted at 70 Longview Road, Reading, MA 01867-2818. Please include an SASE when requesting a reply.*

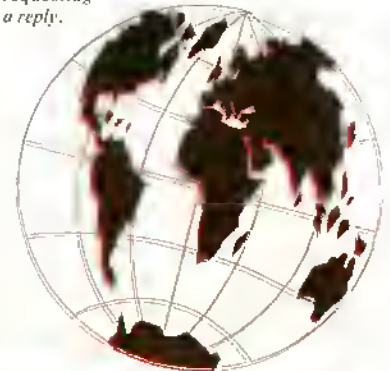

CoCo 3

### The Listing: INORBIT

```

1 'IN ORBIT
2 'BY BARRY J. MITCHEL
3 'COPYRIGHT (C) 1992
4 'BY FALSOFT, INC.
5 'RAINBOW
100 DATAC,C,E,G,G,P4,G,G,P4,E,E,
P4,C,C,E,G,G,P4,G,G,P4,F,F,P4,O-
B,B,D,O,A,A,P4,A,A,P4,F,F,P4,O-B
,B,O+D,A,A,P4,A,A,P4,E,E,P4,C,C,
E,G,O+C,P4,C,C,P4,O-G,G,P4,C,C,E
,G,O+C,P4,C,C,P4,O-A,A,P4,D,D,F,
A,A,P2,P4,F#,G,O+D,P2,P4,O-G,E,E
,P4,D,A,P4,G,C,PBLBC,L4C,CP1
110 PMODE1,1:PCLS2:SCREEN1,0:DR
W"BM0,30C458D38D5032EU30BU6U3FD3
8D7D2B8D4DF3UB3U2BU2U3U3FD3
56D303EU4U35FD346D7DRU2BU7U3F
D2BD2D2B8D8RBU3UBU626RD25B06D
3DD404F0UB6UBU1BU21RD20B06D46D
706EUBU6U5BU5U20D3R0158D50RD204
8D6D6RUGBU13U2BU4U14ED15B04D
120 DRAW"BD14D6RU6BU17UBU5U13BU4
U2RD38D3D12B06D2BD16D6RU5BU17U2B
U7U11BU4U2BD8R9B02705FU6BU27UR
D9D25D6UEU4UBU0BU16U12RND13RD1
2BD18D8BU38RNB0R7BD24RBU25U6RND
6FD58D27D0BU32RD5RU4FD3EU2FB011L
E2D28D8FBUBU2BU4U0BU7ED2B05D2BD
203UEU12RD11B014FU2BU14U12R
130 DRAW"ND10RD9BD19DBU29RD9RUGF
09RU18BU7ED2B04D14FU15BU4U2RD36D
2D17FD3U26RD27FU29EUB32FU33ED34F
U37RD38FLRU39UE36B03D2FU3BU4U35
ED36BD4D3BD02FDU6BU7U20BU6U18D9
RBD922BD4D7FU9RU3U20BU9U10RD12BD
10D3BD2D10BD5D18D9D9F2HU14BU3U1
2BU6UBBU4U2BU9U13FD13BD7D3
140 DRAW"BD4D7BD7D27U2E248UBU3B
U2U2BU12U12FD12BD11DBD3D2BD9D22E
U20BU10U3BU13U14EU027B03D9D12D19
EU17BU17U2GE2BBD17D15U2EU11BU20
U28RD25B02408EU6BU26U25R024BD27D
4EU2BU29U23FD216D3BD2BRBU27U2BU1
4U5FD3BD14D4R93BU16D2BR9B039D4FU
6ED7RU6BU2U2BU6U2EU04BD6D2
150 DRAW"BD2DBRU8BU2U2BU2UBU3NU4
FD6BD308FU10BU3U5RU2303BD13D2BD
4D6BD3D11FD6U18BU3U6BU3U5BU10UR
05D09D6B0306BD3019FD4U24BU3U7BU2
U7BU3U6R048D9D6BD3D8D3D24FU25BU
3U9RU3U5BU10U3FD2B09D6BD2D16D3D0
24EU22BU3U19RD28BD2D1EU20BU2LUE
U17DFD15B05D13EU11BU6U14RD16
160 DRAW"BDRD3D12D2BU17U6BU3U12
8U4U2BU10U2E4D8D9D2BD4D18D4D8BD
11D5RU5BU11UBU3U12BU43BU8U4RD4
BD6D48D5D2FU22BU6U2BU6U3RD26D7D
2BD5D24FD3U32H3GFRD33RU33RD32EU3
2E032RU33BU4HU2EUD5D5B04D033FU3
4BU3U6FD5B03D38FU39BU3U3RD3BD304
0EU38BU3U3RD3BD3D36
170 PLAY"05C":EXEC44539
180 DIMW(57):PMDE1,1:PLAY"T403
190 GET(0,0):(23,191),W:POKE25,1
200:PCOPY129TD1:PCOPY138T02:POKE2
5,PEEK(51):PUT(232,0):(255,191),
W
210 READW:PLAYW:IFW$="CP1"THEN
RESTORE
210 GOTD19R

```

Product Review

# Window Master Desk Accessory Pak

The *Desk Accessory Pak* offers additional features to the *Window Master 3.0* program in the form of desk accessories. These accessories can be easily loaded in one of two ways: You can either run the *DAINSTALL* program from within the *FINDER* program — this installs the accessories when you need them — or you can use the new version of the *W.BAS* program, provided on disk. The latter approach installs the accessories upon each boot of *Window Master 3.0*. This approach also requires a two-drive system.

The accessories package contains a font editor, an icon editor, a calendar program, a terminal package, disk utilities, function-key utilities, a graphics editor, and a version of *Orhella* called *Flip-It*.

The font editor allows you to create original fonts for use with *Window Master*. The system has 10 resident fonts or character sets. To create new sets you must edit one character at a time. For experimentation, I edited a few characters from an existing character set. If you make a mistake prior to saving a character, it is possible to reload the original character. While editing, the resulting character is displayed in a character box. After each character in the set has been edited and saved, you must update the character set to prevent loss of your efforts.

The icon editor is part of the font editor program. If you select *GFX Font* or *GFX Small* from the character-set menu, you're actually choosing to edit icons. The process

of editing icons is handled in a similar fashion to that of font editing.

If you have a need for marking a calendar though don't require a program with all the bells and whistles, the calendar program should suit your needs. The calendar program prompts you to enter the month and year to display. Next, the month is shown and you're able to mark special dates and enter reminders and notes of up to 120 characters per date. Created notes can be saved by month to data files for later recall. Options exist for changing the calendar to a new month and year, redoing a month's notes, opening a previously saved data file, saving a data file, renaming a data file, and exiting the program.

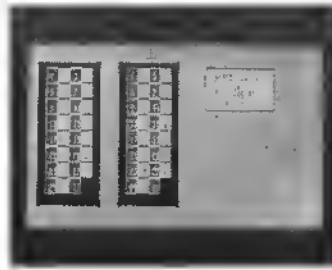

The terminal package provided is simple though workable and handy for light communication needs. It can operate at 300, 1200 and 2400 hps; supports 5 through 8 bits; handles mark, space, none, odd or even parity; supports half- or full-duplex mode; and can communicate through the serial port or use a Deluxe RS-232 Pak. There are three pull-down menus: a File menu for viewing a directory and killing files, a Transfer menu for selecting between sending or receiving using ASCII or Xmodem, and a

screen menu for using a normal or split screen. The split screen provides a conference mode text box for entering text that will not be overwritten by information received on the screen. Users can switch between a graphics screen or an 80-column text screen. The text screen is the faster of the two and is recommended for displaying text at 1200- or 2400-bps.

The disk utilities are similar to those already provided with the *Window Master* package with the exception of a new backup routine. The *Window Master* utilities menu offers an initialization option but no backup option. The range of disk functions now includes formatting, labeling and hacking up disks as well as copying, killing and renaming multiple files. When a function is selected, you're prompted for the destination disk drive.

A powerful feature of *Window Master* is its use of function keys. Function keys can execute programmed routines of up to 250 characters in length. The programming process offered by the accessory program is similar to that offered by the *Fkeys* menu options in the *FINDER* program of *Window Master*. You can program or delete a key, display all keys for quick reference, and save or load a key set. The process of programming is simplicity at its best. You select the key to use (upper- or lowercase), click on the text area and enter the corresponding routine, then save the key set.

If you are a graphics artist or a game player, you too can have some fun using the *Desk Accessory Pak*. The graphics editor provides three graphics modes: a 4-color by 640-resolution, a 16-color by 320, and a 16-color by 640-resolution. The editor supports many text styles and sizes for inclusion with graphics images, graphics tools and editing functions, and the ability to save

and load images. The fat-bits (zoom) mode is great for creating pictures with fine detailing.

How about a game of *Flip-It*? You deserve a break from programming at evenings end. *Flip-It* is a version of *Orhella*, played on a 10-by-10 grid, for two players or one versus the computer. It provides for quite a challenge.

*Window Master* is required to use the *Desk Accessory Pak*. Cer-Comp LTD., 5566 Ricochet Avenue, Las Vegas, NV 89110, 720-452-0632; \$39.95.

— Tony Olive



To determine from within a program which text screen (32-, 40- or 80-column) is being used on the CoCo 3, use *peeks* to Location \$E7 (decimal 231). If the value returned from this peek is 0 (zero), the current screen is 32 columns wide. A returned value of 1 indicates the 40-column screen is in use, and a value of 2 means 80 columns are active. Use these *peeks* to determine the text-screen size, then have your program proceed accordingly.

## Deluxe Terminal V1.0

A Completely New and Easy to use Terminal Program designed specifically for the CoCo III.

With advanced features you would expect to find only in Hi-Priced MS-Dos programs. It has a 26 Entry Phone Directory with complete Configuration information for Communications and Automatic Logon. It supports the Serial I/O port up to 2400 baud, Deluxe & Modem Pak and the Disto Serial I/O board up to 9600 baud. It has a Full Screen Text Editor, X/Y Modem and ASCII file transfer support, Split Screen Conference Mode, Programmable Macro Keys, Full Disk Support including Multifile Copy, Kill, Renate, Archive, Un-Archive and Disk Initialize and it is completely compatible with ADOS. It allows complete customization of Display Colors, Printer & Serial Communications, Drive Step Rates and Directory Sorting preference. It requires a 128K CoCo III, 1 Disk drive and an 80 Column display. Special Introductory price of \$34.95

To order by VISA, MASTERCARD or COD  
Call Toll Free 1-800-383-8529  
(Monday thru Saturday, 8am to 5pm PST).  
To order by mail, send check or money order for the amount of the program plus \$4.00 for shipping and handling to:  
**Cer-Comp Ltd.**  
5566 Ricochet Avenue  
Las Vegas, NV 89110  
702-452-0632

## we have over 1500 programs for your coco

ISSUE 007, MAY, 1991 BUSINESS PLAN LETTIME RULER MATHOFFBY BEECHER PRESS I I ORSA ATTACK MORRISRAM CONTE'S CLIM SCHEIN'S FISHNET DZLOW GOLF	ISSUE 108, JUNE, 1991 STROM GENDREAR HIDE DIRECTORY LOTT TWISTERS CLUB FORTVIVE SMACK SHARK CIVIL WAR 3 SPELLING QUIZ COTY'S CLIMB CUBIC 4	ISSUE 409, JULY, 1991 DESI UNKNOV FAY CONVENTION FINDMANSY OUT BETTINS ODDS 3 INX 13 CODE 1 TV SCRAMBLE FORM LETTER DIXONS FRACTIONS KISHARD PROTECT KISHARD	ISSUE 008, AUG, 1991 WEDONS PLANNOR PALDYS LEGEND TO DO LIST MONTER GRAPHICS 3 OLD TIME STAFF MIS THE Y FRACTIONS BIB FOR BRIDIS 5 DIBMARS 3 BIBRO THMOIC THEORIC
ISSUE 011, SEPT, 1991 REAGONS FILE OUT OF CHAOS RE-HIGHWAY 20CT ALBERT WYACK 3 PORKY 3 FINANCE BUNDLE SILENCE SYNDROME MR. BILL COAST TO COAST	ISSUE 012, OCT, 1991 BUNGLE BELLE PALA PLATEN KESST MAS GRIFFIN 10 SERPENT FORWARD DICE LOMO TIGOLS ENRIME OUTST	ISSUE 013, NOV, 1991 CHADZ BIRDS CA VETER OF GUNT DEADLY AGREANT TELE SALE THE BUSH COURTNEY WABOR WIRE 3 SCHEINABLE 1/2/2/F	ISSUE 014, DEC, 1991 MORRIS DCS DRAV LOW RES 1 + 2 THE BAR KLE 9853 CH V SUNNY ATTACK MATH SPEAR 2 DREAM SWAMP AD TEST MACK 6 TEBUES 3 CUBES 3 RE-REVIEW 3

## Public domain programs... Great appetizers for a hungry computer!

- Music 1-7**
  - M1 - 8 Lyndon & P Songs
  - M2 - 15 Music Files
  - M3 - 18 Music Files
  - M4 - 18 Music Files
  - M5 - 15 Music Files
  - M6 - 13 Disk Files ready to play
  - M7 - 13 Disk Files ready to play
- GAMES 1-11**
  - G01 - 18 Digits or Colors 11 Programs
  - G02 - BlueBox, Polka, Rock-out, Strands
  - G03 - Auto-Ride, Drive, Drive, Viper, Viper, Viper
  - G04 - 18 High scores, Grenade, Pyrene, Sahara
  - G05 - How To 1 man's World, Nucleo, Shoreside
  - G06 - Football, Funken, Kazzoo, Lory
  - G07 - Kines Army, Nourpans, Shup, Shillo
  - G08 - Cannon 1 P 16, Fly, Rite, Life
  - G09 - Football, Green Attack, Okavio, Slop
  - G10 - Bubbles 10, Muzzle, Scissors
  - G11 - Dasher's, Dime, Snake Attack, Tuffies
- HOME MANAGEMENT 1-4**
  - H1 - Programs Each Day/Year
  - H2 - Checkbook, Budgets, Expense Dates
  - H3 - Check 1 of Wall Paper, Expenses
  - H4 - Expenses, Life, Insurance Rates
  - H5 - Special 1 of Spring Doctor
- Utilities 1-4**
  - U1 - Programs Each, All 1's Storage Disk
  - U2 - 1000's Disk, Zipper, Bush Fight, Hays, Vag
  - U3 - Backup, Deflate, Defragment, Offer, Set Pkg
  - U4 - Fanfare, Disk Library, L3D, Pac, S9scape
  - U5 - 1000's Disk, Disk, Money, Etc, Zap 1 Pack
  - U6 - Amulet, Bate 94, 5134, Slopans
  - U7 - 64 Lines, 1000's Disk, L3D, Slopans
  - U8 - Lotus Word prog with 100's of macros
  - U9 - Fig 70's bit prog work materials
- Education 1-4**
  - E1 - 11 Programs for young Kids
  - E2 - 11 Programs for High School Kids
  - E3 - 11 Programs To Use Ceres custom disk
  - E4 - 11 Games Programs About Aardvark
- Graphics 1-14**
  - G01 - R-Action, Fudge, Snow
  - G02 - Jigsaw, Geometry, Wordplay
  - G03 - 3 Ceres 3 Graphic programs
  - G04 - 21 Ceres 3rd Programs
  - G05 - 11 Ceres 3rd Programs
  - G06 - 22 Lines 3rd Programs
  - G07 - 15 Lines 3rd Programs
  - G08 - 11 IBM Programs
  - G09 - 11 IBM Programs
  - G10 - 11 Large 3rd Programs
  - G11 - 11 3rd Programs
  - G12 - Ceres 3rd 3 Programs
  - G13 - Mappert Graphic 1 & 2
  - G14 - 5 Macintosh Patterns
- Adventures 1-2**
  - A1 - USA, David, Wag, Gargoyles, Kites, Iron, King
  - A2 - Denny, Nucleo, Snake, Wars, and, Wabbit
  - A3 - Avians, Dore, Lane, Offspring, Hologram, Ice, One, Sore, Sore, Sore, Sore, Sore

## Feed your Coco with our software today!

Mail To:  
T&D Subscription Software  
2490 Miles Stadium Drive  
Hoffman IL 60424  
(616) 390-9648  
Fax: (616) 391-2744

Single Issue (Tape or Disk)..... \$ 8.00  
3-5 ISSUES..... \$ 6.00 Ea.  
10 Issues..... \$ 5.00 Ea.  
11 or more Issues..... \$ 4.50 Ea.  
All Our Software (196 Disks)..... \$ 285.00  
One Year Subscription..... \$ 60.00

Name \_\_\_\_\_  
Address \_\_\_\_\_  
City \_\_\_\_\_ State \_\_\_\_\_ Zip \_\_\_\_\_  
Credit Card # \_\_\_\_\_  
Expiration \_\_\_\_\_ Total \$ \_\_\_\_\_  
I Please Enclose: TAPE or DISK

Feature Program

# Move Print@ to a New Location

Have you ever tried to run a CoCo 1 (or 2) program on the CoCo 3's Hi-Res text screens and had PRINT@ statements get in your way? If so (and if you persevered in the attempt), you know how tedious and time-consuming it can be to convert those PRINT@s into appropriate LOCATE statements for the CoCo 3. I've owned a Color Com-

puter since 1981, and I have a lot of older programs. I wrote *Convert* to make an easier job of converting my software for the CoCo 3. *Convert* reads a BASIC program and changes all occurrences of PRINT@ to LOCATE, adding appropriate screen coordinates.

Before proceeding, enter the listing and

save it to disk as *CONVERT.BAS*. When you first run the program, you are prompted for the name of program you want to convert. The file must be a BASIC program that has been saved on disk in ASCII format. (To save a BASIC program in ASCII, use the .A option described with the SAVE command in your disk-drive manual.) After this, you are

prompted for an output filename. This is the new name (it must be different than the input filename) under which you want the converted program saved. *Convert* uses LINEINPUT statements for both prompts, so you can add filename extensions and drive numbers. Finally, you are prompted for whether you want the PRINT@ statements converted for 40 or 80 columns.

*Convert* reads line-by-line through the ASCII file searching for PRINT@ (the target string set up in Line 300). If it finds this string, it searches for more occurrences within the same line. If the target string is not found in the current line, the program dumps the line into the output buffer.

After *Convert* has found all occurrences of the target string in a specific line, the program branches to the conversion subroutine. There it converts the PRINT@ number into column and row values for a 32-column screen and multiplies these values by a conversion factor. The program then rebuilds the line character-by-character, replacing PRINT@abc with LOCATE xx,yy:PRINT. The converted program is saved to disk in ASCII format.

**Caveats**

I've tried to make *Convert* as crash-proof as possible, and so far it has worked with all the programs I've converted. However, there are a few things to keep in mind when using *Convert*. First, the Color Computer can handle only 255 characters in a program line. If you have a line "pushing the envelope" (say, above 220 characters), you should break it into two or more lines. The reason for this is simple: The LOCATE statement is much longer than the PRINT@ statement, and the converted line may be longer than 255 characters.

The string variable that holds the converted line as it is built is C@S (Line 520). If the length of the contents of this variable goes over 255 characters, the operating system will return an LS error (string too long). The error-trap subroutine in *Convert* informs you of the error, closes all files, and deletes the partial destination file.

Another thing to remember is that *Convert* can handle up to 11 PRINT@ commands in a given line, though a more practical limit is eight PRINT@s. You'll probably get an LS error long before 11 conversions. I've run the program and have converted up to seven PRINT@ statements in one line.

Finally, there is a loss of proportion when converting locations for a 32-column screen to an 80-column screen. Although data is placed correctly on the screen, the characters, words and screen structure change proportionally. The effect is less noticeable on the 40-column screen. To regain the proper sense of proportion, you may need to fine tune some of the LOCATE values.

*Mike Woolridge is a weather forecaster with the National Weather Service. He may be contacted at 1066 Solon Court, Dunbar, WV 25064, (304) 768-1052. Please include an SASE when requesting a reply.*

Yes! They're still available!

## RAINBOW Back Issues

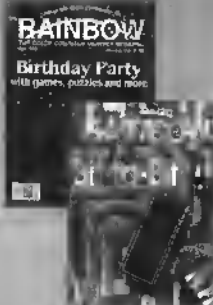

**BACK ISSUES STILL AVAILABLE**  
Have you explored the wealth of information in our past issues? From our very first, four-page issue to many with more than 300 pages of material, it's all just for CoCo users — a great way to expand your library!

**A WORLD OF INFO AT A BARGAIN PRICE**  
All back issues sell for the single issue cover price. In addition, there is a \$3.50 charge for the first issue, plus 50 cents for each additional issue for postage and handling if sent by

United Parcel Service. There is a \$5 charge for the first issue, plus a \$1 charge for each additional issue on orders sent by U.S. Mail. UPS will not deliver to a post office box or to another country.

**MOST ISSUES STILL AVAILABLE**  
Available issues through June 1982 are provided on white paper in a reprint form. All others are in regular magazine form. VISA, MasterCard and American Express accepted. Kentucky residents please add 6 percent sales tax; Canadian residents, 7 percent GST. In

order to hold down costs, we do not bill, and no C.O.D. orders are accepted.

Due to heavy demand, we suggest you order the back issues you want now while supplies last.

To order, review and fill out the form below and mail it with your payment.

For greater convenience, order through the Rainbow Magazine Services area of our Delhi CoCo SIG.

**RAINBOW INDEX**

A complete index for July 1981 through June 1984, is printed in the July 1984 issue. Separate copies are available for \$2.50 plus 50c handling. Indexes for subsequent years are published annually in the July issues of THE RAINBOW.

TOTAL \_\_\_\_\_  
 KY RESIDENTS ADD 6% \_\_\_\_\_  
 CANADIAN RESIDENTS ADD 7% GST \_\_\_\_\_  
 U.S. MAIL CHARGE \_\_\_\_\_  
 SHIPPING & HANDLING \_\_\_\_\_  
 U.P.S. CHARGE \_\_\_\_\_  
 TOTAL AMOUNT \_\_\_\_\_  
 ENCLOSED \_\_\_\_\_

**Article Reprints**

In instances where a given issue is now out of print and not available for purchase, we do provide photocopies of specific articles. The cost for this service is \$1.50 plus 50 cents \$/H per article. This service is provided only in the case of out-of-stock issues.

Name \_\_\_\_\_  
 Address \_\_\_\_\_  
 City \_\_\_\_\_ State \_\_\_\_\_ Zip \_\_\_\_\_  
 Payment Enclosed, or Charge to my:  VISA  MC  AE  
 Card # \_\_\_\_\_  
 Expiration Date \_\_\_\_\_ Phone ( ) \_\_\_\_\_  
 Signature \_\_\_\_\_

**TO ORDER BY PHONE** (credit card orders only) call (800) 847-0309, 9 a.m. to 5 p.m. EST. At other inquiries call (502) 228-4492, send to: THE RAINBOW, The Fatsort Building, P.O. Box 385, Prospect, KY 40059

**Please send me the following back issues:**

JUL 81	VOLUME 1	PRIMER ISSUE	\$2.00	<input type="checkbox"/>	APR 84	Gaming	\$3.95	<input type="checkbox"/>
EEB 82	VOLUME 1	PRIMER ISSUE	\$2.00	<input type="checkbox"/>	MAY 84	Printer	\$3.95	<input type="checkbox"/>
JUN 83	VOLUME 2	PRINTERS	\$2.95	<input type="checkbox"/>	JUN 84	Music	\$3.95	<input type="checkbox"/>
AUG 83	VOLUME 3	GAMES	\$2.95	<input type="checkbox"/>	SEP 84	Anniversary	\$3.95	<input type="checkbox"/>
SEP 83	VOLUME 3	GAMES	\$2.95	<input type="checkbox"/>	AUG 84	Gaming	\$3.95	<input type="checkbox"/>
OCT 83	VOLUME 3	GRAPHICS	\$3.95	<input type="checkbox"/>	SEP 84	Education	\$3.95	<input type="checkbox"/>
MAR 84	VOLUME 3	BUSINESS	\$3.95	<input type="checkbox"/>	OCT 84	Graphics	\$3.95	<input type="checkbox"/>
					NOV 84	Data Comm.	\$3.95	<input type="checkbox"/>

DEC 84	Holiday	\$3.95	<input type="checkbox"/>	FEB 88	Home Help	\$3.95	<input type="checkbox"/>		
JAN 85	Beginners	\$3.95	<input type="checkbox"/>	MAR 89	Hardware	\$3.95	<input type="checkbox"/>		
FEB 85	Utilities	\$3.95	<input type="checkbox"/>	APR 89	Business	\$3.95	<input type="checkbox"/>		
MAR 85	Business	\$3.95	<input type="checkbox"/>	MAY 89	Printer	\$3.95	<input type="checkbox"/>		
APR 85	Simulations	\$3.95	<input type="checkbox"/>	JUN 89	Summer Fun	\$3.95	<input type="checkbox"/>		
MAY 85	Printer	\$3.95	<input type="checkbox"/>	JUL 89	Anniversary	\$3.95	<input type="checkbox"/>		
JUN 85	Music	\$3.95	<input type="checkbox"/>						
JUL 85	Anniversary	\$3.95	<input type="checkbox"/>						
AUG 85	VOLUME 6	Games	\$3.95	<input type="checkbox"/>	AUG 88	Beyond BASIC	\$3.95	<input type="checkbox"/>	
SEP 85	VOLUME 6	Education	\$3.95	<input type="checkbox"/>	SEP 88	Education	\$3.95	<input type="checkbox"/>	
OCT 85	VOLUME 6	Graphics	\$3.95	<input type="checkbox"/>	OCT 88	Graphics	\$3.95	<input type="checkbox"/>	
NOV 85	VOLUME 6	Data Comm.	\$3.95	<input type="checkbox"/>	NOV 88	Data Comm.	\$3.95	<input type="checkbox"/>	
DEC 85	VOLUME 6	Holiday	\$3.95	<input type="checkbox"/>	DEC 88	Holiday	\$3.95	<input type="checkbox"/>	
JAN 86	VOLUME 6	Beginners	\$3.95	<input type="checkbox"/>	JAN 89	Beginners	\$3.95	<input type="checkbox"/>	
FEB 86	VOLUME 6	Utilities	\$3.95	<input type="checkbox"/>					
MAR 86	VOLUME 6	Business	\$3.95	<input type="checkbox"/>					
APR 86	VOLUME 6	Home Help	\$3.95	<input type="checkbox"/>					
MAY 86	VOLUME 6	Printer	\$3.95	<input type="checkbox"/>					
JUN 86	VOLUME 6	Music	\$3.95	<input type="checkbox"/>					
JUL 86	VOLUME 6	Anniversary	\$3.95	<input type="checkbox"/>					
AUG 86	VOLUME 8	Games	\$3.95	<input type="checkbox"/>	AUG 90	VOLUME 10	OS-9	\$3.95	<input type="checkbox"/>
SEP 86	VOLUME 8	Education	\$3.95	<input type="checkbox"/>	SEP 90	VOLUME 10	Education	\$3.95	<input type="checkbox"/>
OCT 86	VOLUME 8	Graphics	\$3.95	<input type="checkbox"/>	OCT 90	VOLUME 10	Graphics	\$3.95	<input type="checkbox"/>
NOV 86	VOLUME 8	Data Comm.	\$3.95	<input type="checkbox"/>	NOV 90	VOLUME 10	Data Comm.	\$3.95	<input type="checkbox"/>
DEC 86	VOLUME 8	Holiday	\$3.95	<input type="checkbox"/>	DEC 90	VOLUME 10	Holiday	\$3.95	<input type="checkbox"/>
JAN 87	VOLUME 8	Beginners	\$3.95	<input type="checkbox"/>	JAN 91	VOLUME 10	Beginners	\$3.95	<input type="checkbox"/>
FEB 87	VOLUME 8	Utilities	\$3.95	<input type="checkbox"/>	FEB 91	VOLUME 10	Home Help	\$3.95	<input type="checkbox"/>
MAR 87	VOLUME 8	Business	\$3.95	<input type="checkbox"/>	MAR 91	VOLUME 10	Hardware	\$3.95	<input type="checkbox"/>
APR 87	VOLUME 8	Home Help	\$3.95	<input type="checkbox"/>	APR 91	VOLUME 10	Music	\$3.95	<input type="checkbox"/>
MAY 87	VOLUME 8	Printer	\$3.95	<input type="checkbox"/>	MAY 91	VOLUME 10	Printer	\$3.95	<input type="checkbox"/>
JUN 87	VOLUME 8	Music	\$3.95	<input type="checkbox"/>	JUN 91	VOLUME 10	Summer Fun	\$3.95	<input type="checkbox"/>
JUL 87	VOLUME 8	Anniversary	\$3.95	<input type="checkbox"/>	JUL 91	VOLUME 10	Anniversary	\$3.95	<input type="checkbox"/>
AUG 87	VOLUME 7	Games	\$3.95	<input type="checkbox"/>	AUG 91	VOLUME 11	Graphics	\$3.95	<input type="checkbox"/>
SEP 87	VOLUME 7	Education	\$3.95	<input type="checkbox"/>	SEP 91	VOLUME 11	Education	\$3.95	<input type="checkbox"/>
OCT 87	VOLUME 7	Graphics	\$3.95	<input type="checkbox"/>	OCT 91	VOLUME 11	OS-9	\$3.95	<input type="checkbox"/>
NOV 87	VOLUME 7	Data Comm.	\$3.95	<input type="checkbox"/>	NOV 91	VOLUME 11	Data Comm.	\$3.95	<input type="checkbox"/>
DEC 87	VOLUME 7	Holiday	\$3.95	<input type="checkbox"/>	DEC 91	VOLUME 11	Holiday	\$3.95	<input type="checkbox"/>
JAN 88	VOLUME 7	Beginners	\$3.95	<input type="checkbox"/>	JAN 92	VOLUME 11	Utilities	\$3.95	<input type="checkbox"/>
FEB 88	VOLUME 7	Utilities	\$3.95	<input type="checkbox"/>	FEB 92	VOLUME 11	Home Help	\$3.95	<input type="checkbox"/>
MAR 88	VOLUME 7	Business	\$3.95	<input type="checkbox"/>	MAR 92	VOLUME 11	Hardware	\$3.95	<input type="checkbox"/>
APR 88	VOLUME 7	Home Help	\$3.95	<input type="checkbox"/>	APR 92	VOLUME 11	Music	\$3.95	<input type="checkbox"/>
MAY 88	VOLUME 7	Printer	\$3.95	<input type="checkbox"/>	MAY 92	VOLUME 11	Printer	\$3.95	<input type="checkbox"/>
JUN 88	VOLUME 7	Music	\$3.95	<input type="checkbox"/>	JUN 92	VOLUME 11	Summer Fun	\$3.95	<input type="checkbox"/>
JUL 88	VOLUME 7	Anniversary	\$3.95	<input type="checkbox"/>	JUL 92	VOLUME 11	Anniversary	\$3.95	<input type="checkbox"/>
AUG 88	VOLUME 8	Games	\$3.95	<input type="checkbox"/>					
SEP 88	VOLUME 8	Education	\$3.95	<input type="checkbox"/>					
OCT 88	VOLUME 8	Graphics	\$3.95	<input type="checkbox"/>					
NOV 88	VOLUME 8	Data Comm.	\$3.95	<input type="checkbox"/>					
DEC 88	VOLUME 8	Holiday	\$3.95	<input type="checkbox"/>					
JAN 89	VOLUME 8	Beginners	\$3.95	<input type="checkbox"/>					

CoCo 3 Disk

The Listing: CONVERT

```

1 *PRINT@ CONVERTER
2 *BY MIKE WOOLRIDGE
3 *COPYRIGHT (C) 1992
4 *BY FALSOFT, INC.
5 *RAINBOW MAGAZINE
10 CLEAR 5000
20 ON ERR GOTO 820
30 AA=40
40 DIM PS(11)
50 DIM PE(11)
60 DIM PN(11)
70 DIM RPS(11)
80 CLS
90 LINE INPUT "FILE TO BE CONVER
TED...";AS
100 PRINT
110 LINE INPUT "NAME OF CONVERTF
O FILE...";BS
120 PRINT
130 PRINT"CONVERT PRINT@ STATEH
ENTS TO: "
140 PRINT"      1. 40 COLUMN S
CREEN"
150 PRINT"      2. 80 COLUMN S
CREEN"
160 INPUT A:IF A<1 OR A>2 THEN C
LS:GOTO 130
170 IF A=1 THEN AA=40 ELSE AA=80
180 WIDTH AA
190 PRINT "CONVERTING FILE ";AS
200 PRINT
210 PRINT "TO FILE ";BS
220 PRINT
230 PRINT "FOR SCREEN SIZE OF":A
A
240 PRINT
250 PRINT "PLEASE WAIT..."
260 OPEN "1",#1,AS
270 OPEN "0",#2,BS
280 LINE INPUT#1,IPS
290 IF EOF(1)--1 THEN CLOSE#1:OP
--1
300 TGS="PRINT@"
310 PS(1)=INSTR(1,IPS,TGS)
320 IF PS(1)=0 THEN PRINT#2,IPS
ELSE GOTO 340
330 IF OP=-1 THEN 590 ELSE GOTO
280
340 FOR X=2 TO 10
350 PS(X)=INSTR(PS(X-1)+1,IPS,TG
S)
360 IF PS(X)=0 THEN GOTO 380
370 NEXT X
380 FOR Z=1 TO X-1
390 FOR V=PS(Z)+5 TO PS(Z1+10
400 CCS=HIDS(IPS,V,1)
410 IF CCS="@" THEN C=Y
420 IF CCS="-" THEN PE(Z)=V:PN(Z
)-VAL(MIDS(IPS,C+T,V-1)):C=0
430 NEXT V
440 NEXT Z
450 HM=X-1
460 GOSUB 610
470 C=1
480 FOR VV=1 TO LEN(IPS)
490 IF C>HM THEN GOTO 510
500 IF VV=PS(C) THEN CCS=CCS+RPS
(C):VV=VV+PE(C):PS(C):C=C+1:GOTO
530
510 CCS=MIDS(IPS,VV,1)
520 CC5=CC5+CCS
530 NEXT VV
540 IPS=CC5
550 PRINT#2,IPS
560 CC5="":CC5=""
570 IF OP=-1 THEN GOTO 590
580 GOTO 280
590 CLS:PRINT "PROGRAM HAS BEEN
CONVERTED."
600 END
610 'SBR FOR NUMBER CONVERSION
620 FOR K=1 TO MH
630 J=PN(K)
640 IF J<0 THEN J=0
650 IF J>511 THEN J=511
660 Y=INT(J/32)
670 X=J/32
680 Z=X-Y
690 Y=Y+1
700 Z=(Z+32)+1
710 IF AA<80 THEN Z=Z ELSE Z=Z*2
720 YY=(Y-1)*1.5
730 ZZ=(Z-1)*1.25
740 IF YY={INT(YY)}<0.5 THEN YY=
INT(YY) ELSE YY=INT(YY)+1
750 IF ZZ={INT(ZZ)}<0.5 THEN ZZ=
INT(ZZ) ELSE ZZ=INT(ZZ)+1
760 XX=STR$(ZZ):XX$=RIGHT$(XX$,
LEN(XX)-1)
770 YYS=STR$(YY):YYS=RIGHT$(YYS,
LEN(YYS)-1)
780 RPS(K)="LOCATE "+XX$+" "+YYS
790 RPS(K)=RPS(K)+";PRINT "
800 NEXT K
810 RETURN
820 'ERROR TRAP SUBROUTINE
830 IF ERNO=14 THEN PRINT"STRING
TOO LONG!";PRINT "SHORTEN THIS
LINE...";PRINT CCS;CLOSE#1;CLOSE
#2;KILL BS:END
840 IF ERNO=26 THEN PRINT "CAN N
OT FIND THAT FILE!...TRY AGAIN!";
FOR K=1 TO 100:NEXT K:RUN
850 CLS:PRINT "ERROR NUMBER...";
ERNO;" IN LINE NUMBER...";ERLIN;
END
    
```

Product Review

The CoCo Family Recorder

OK, you've been asking for it, now here it is. *The CoCo Family Recorder* is a unique program designed to keep track of family members in a genealogy environment. The resultant database of information is designed to show relationships between ancestors and relatives. The database is limited to a maximum of 500 individuals and 200 marriages. There are a number of files on the 5 1/4-inch disk that comes with the package;

**CREATPER** — Formats and creates the data file *PERSFILE* which contains personal information.

**CREATMAR** — Formats and creates the data file *MARRFILE* which contains marriage information.

**UPDATPER** — Allows entering information into the *PERSFILE* as well as making changes at a later date.

**UPDATMAR** — Allows entering information into the *MARRFILE* as well as making changes at a later date.

**INDEXPC** — Creates an index file called *PCINDEX* which relates children to their respective parents.

**INDEXMAR** — Creates an index file called *MINDEX* which relates husbands and wives

together.

**LISTPER** — Prints a list of all the names in the *PERSFILE* in order of record number.

**LISTMAR** — Prints a list of all the marriages in the *MARRFILE*.

**LISTPC1** — Prints a list of all parents and their children.

**PRINTPER** — Prints individual person records as requested.

**PRINTMAR** — Prints individual marriage records as requested.

**WORKSH1** — Prints an information worksheet that can be used as an aid in gathering the necessary information for the database.

Because of the relationships varied within the personal files, pedigree information may be associated backwards for any number of generations. There is no specific limit to the number of generations the program will handle. Because of the parent/child index, which relates parents to their children and the marriage index, it is possible to relate any number of persons together in family groups. Expanded family groups can be shown by combining the pedigree chart with the family group printouts. A very helpful booklet can be produced by displaying pedigree charts followed by the listed family groups.

The personal information files contain such things as a person's name, date and

location of birth, and parents. If appropriate, it also contains the date of death and burial information. Pedigree information is that information which shows parents, grandparents, etc., and direct ancestry. Family group information is that information about a marriage, the children of that marriage, and the date and location of the marriage, as well as person file numbers. *The CoCo Family Recorder* is entirely menu-driven and thus very easy to use. It requires a CoCo 3 with at least two disk drives and a monitor capable of 80-column text. All Tandy DMP and Epson/IBM-compatible printers are supported. A well-written and -documented 14-page instruction booklet is provided and needed in order to fully understand the various functions and capabilities of the program.

This is a long-awaited program that will be welcomed by many in the CoCo community. The various screens are well-designed and the layout is simple, yet practical. *The CoCo Family Recorder* is priced fairly and does what it's advertised to do. If you are interested in genealogy and use a CoCo 3, this program will be a welcome addition to your library. (Farna Systems, 904 2nd Ave., Robins AFB, GA 31098; \$29.95. A demo version is available for \$5, which is refunded when you purchase the regular version.)

— Robert Gray



TIP

If you find that a line in a listing you are entering is too long, the reason might be that it is padded. When you enter a BASIC program line, the computer watches the length of that line: when it reaches 240 characters, the computer refuses to accept more.

If you need to get a few more characters into the line, press **ENTER** to place what you've already typed into memory, then type **EDIT** and the line number followed by **ENTER**. Press **X** (for extend) to move the cursor to the end of the line. Now you can enter more characters. The Edit mode has its own length limit, though, so the computer will take a few more characters and stop again.

This trick does let you stretch your lines (saving memory and slightly increasing speed), but it often causes confusion when someone who doesn't know about it enters a line from a program listing. Also, if you cram too many additional characters into a line, you may find they won't print correctly even though they are actually present. Finally, padded listings will not save properly in ASCII format. Because of these problems, we don't recommend using the technique in programs intended for publication. Still, some get through, and we want you to know how to deal with them when they do.

PRICES SLASHED ON ALL ADOS PRODUCTS LIMITED TIME ONLY!

EXTENDED ADOS-3 .....\$29.95  
(Requires ADOS-3)  
 65% real time 2 lock driver 15  
 Adapter for computers lacking 15 bit ROM add-on \$10

ADOS-3 .....\$24.95

EXT. ADOS-3 PLUS ADOS-3 .....\$49.95

SMARTWATCH REAL-TIME CLOCK .....\$29.95  
Watch in continuous real time on ROM socket or in ROM card  
 \$10. Includes OS-9 1 watch driver. EXT ADOS-3 driver \$0.49  
 card \$10 separately

ADOS FOR CoCo 1 and 2 .....\$14.95

All ADOS software is sold on disk with compatibility software that is tested on EPROMs and is free. Info mail on it grouped by \$15. See our power-ups and upgrades in July 1987 and October 1989 Rainbows (a \$3.95 or \$4.95 for product descriptions)

SPECTROSYSYSTEMS  
 1301 E. Longport Dr.  
 Suite A108  
 Miami, FL 33176  
 (305) 376-3000

SUPPORT FOR OSK/OS9!

Featuring software from:

- IMS •
- Sub-Etha •
- Bob van der Poel •
- Public Domain OSK/OS9 •
- More Coming! •

Send long SASE for PD list (state OSK or OS9)

VED/OSK • \$39.95  
 CheckBook/OSK • \$29.95

Blackhawk Enterprises  
 P.O. Box 10552  
 Enid, OK 73706-0552  
 405-234-2347 9am-1pm CST

TETRIS

Falling block puzzle for 1-3 players. 32K DECB

PYRAMIM

Speed & Strategy!  
 Based on Chinese game of NIM. 32K DECB

CUCKOO

Teach young ones how to read a clock face. 32K DECB

KID-DRAW

Colorful text & graphics.  
 Simple enough for pre-school. 32K DECB

DISK JOCKEY

Tame your disks! Features file manager, long file names, notepad and calculator. 128/512K DECB

\$19.95 each, all four for \$39.00!  
 (\$2 S&H. CT residents add 6% tax)

The Gibraltar Software Co.  
 65 Bluff Avenue  
 Rowayton, CT 06853

NEW! The CoCo Family Recorder

Genealogy data system. Print & store all records! Requires drive 0 & 1, 80 column monitor, 128K DECB - \$24.95

KEEP-TRAK: General Ledger, Double entry

small business system. 32K DECB - \$24.95

ACCOUNTS RECEIVABLE for above - add \$10

BOB'S MAGIC Graphics Machine

Creates basic graphics for your programs with a joystick. 32K DECB - \$19.95

OMEGA FILE Database: Up to 16 fields, 255

char, Menu driven! 32K DECB - \$24.95

FARNA Systems

904 2nd Ave., Warner Robins, GA 31098-1029  
 912-329-7859 - Add \$1.50 S&H (GA add 5% tax)

Would you like your ad here? Very reasonable rates! Choose this size, above, or at left. Call or write FARNA (Rainbow approved!)

# Matchmaker, Matchmaker

**H**ave you ever wanted to run a computerized dating service or pen-pal club? What about pairing up people as roommates for camp or at school? Or running a tournament where people are matched based on their abilities and what times they're available to play? Using the Color Computer, *Matchmaker* makes these tasks far easier than if they were done by hand.

*Matchmaker* is designed to pair people based on similar criteria. Before running the program, get the people you want to pair to answer the questions you want to use for matching them. When deciding how to set up the questionnaire, keep in mind *Matchmaker* expects numeric input -- use questions that lead to a numerically scaled ranking of ability, desire, etc. (more on this in a moment). Then run *Matchmaker* and use the Enter New Data option to enter the criteria you are using to match compatible people. You can use a sentence, or just a word to remind yourself. You can also weigh each criterion. For example, if two players aren't available at the same time, it doesn't much matter whether they are of the same ability. So you would enter a relatively large weighting number for the time criterion, and use a small weight for ability.

Once you have entered the criteria, enter the names of the people you want to pair. As written, *Matchmaker* supports up to 50 people and 20 criteria. If your computer has enough memory, you can easily change these numbers in Line 10: Variable MN represents the maximum number of people and

MC represents the maximum number of criteria. As you enter people's names, you must also enter a number score for each criterion. Once you've entered the data, *Matchmaker* matches the most compatible pairs (those "couples" having the most similar scores in each question) for you.

You must decide for yourself when setting up the criteria what numbering system to use. For example, you might have all questions ranked on a scale from 1 to 5. A person with high ability might get a 5 and a person with moderate ability, a 3. A Yes response to a question might be a 5, and a No might be a 1. *Matchmaker* accepts numbers from 1 to 100; the important thing is that you use a consistent scale for each person on any given question.

*Matchmaker* is designed to work on any CoCo with at least 16K. Extended BASIC is not required, and the program automatically knows whether you are using a tape recorder or a disk drive (Line 300). *Matchmaker* allows you to save, load, add to, or print the data. These options are fairly self-explanatory, and their use should not present any problems.

*Kevin Speight is a student who enjoys using his CoCo for programming and word processing. He can be contacted at Box 266, Howe Hall, Dalhousie University, Halifax, Nova Scotia B3H 4J5. Please include an SASE when requesting a reply.*

```

**+$(CO,1):A=A+1:IF ACN THEN 90
150 FORX=1TO1:IF LEFT$(S$(X,1),1)
)=-* THEN S$(X,1)=RIGHT$(S$(X,1)
),LEN(S$(X,1))-1)
160 NEXTX
170 PRINT:INPUT"ENTER":PS
180 CLS:PRINT:PRINTSTRING$(32,15
6):TAB(11):"MATCHMAKER":PRINTSTR
ING$(32,147):IAB(8):"BY KEVIN SP
EIGHT"
190 PRINT:PRINT"CHOOSE":PRINTTAB
B(10)1) LOAD DATA:PRINTTAB(10)
"2) SAVE DATA:PRINTTAB(10)3) E
NTER NEW DATA:PRINTTAB(10)4) A
DD TO DATA:PRINTTAB(10)5) PROO
UCE PAIRINGS:PRINTTAB(10)6) OU
IT"
200 IS=INKEY$:IE IS="*"THEN200 EL
SE T=VAL(CI$):IF I<1 OR I>6 THEN
200 ELSE ON I GOTO 210,240,250,2
70,60,280
210 CLS:PRINT"ARE YOU SURE YOU
WANT TO LOAD DATA (ANY DATA IN
MEMORY WILL BEERASEO)? YES OR NO
?"
220 IS=INKEY$:IF IS="*"THEN220 EL
SE IF IS="Y" THEN 230 ELSE 180
230 GOSUB300:OPEN "1",#DN,PS:INP
UT#0N,VF:IFVF<>33THENCLOSE#0N:GO
TO180 ELSEINPUT#0N,N:INPUT#0N,C:
FORX=1 TO N:FOR Y=1 TO C+1:LINE
INPUT#0N,S$(X,Y):NEXTY,X:FORX=1T
O C:LINE INPUT#0N,Q$(Y):INPUT#0N
,O(Y):NEXTY:CLOSE#0N:GOTO180
240 IFN<1 THEN180 ELSEGOSUB300:O
PEN#0N,#0N,FS:PRINT#0N,33:PRINT#
0N,N:PRINT#0N,C:FORX=1 TO N:FOR
Y=1 TO C+1:PRINT#0N,S$(X,Y):NEXT
Y,X:FORX=1TOC:PRINT#0N,Q$(X,Y):PR
INT#0N,O(Y):NEXTY:CLOSE#0N:GOTO18
0
250 CLS:PRINT"ARE YOU SURE YOU W
ANT TO ENTER NEW DATA? (ANY OLO
DATA IN MEMORY WILL BE LOS
T) YES OR NO?"
260 IS=INKEY$:IE IS="*"THEN 260 E
LSE IF IS="Y" THEN 20 ELSE180
270 IFN>MN/2 OR N=0 THEN180 ELSE
CLS:INPUT"HOW MANY PEOPLE TO ADD
":NN:IFNN/2<>INT(NN/2) THEN INPU
T"PLEASE LEAVE SOMEONE OUT. AN
EVEN NUMBER NEEDED <ENTER>":PS
:GOTO270 ELSE IFNN<1 OR NN>MN
THEN 270 ELSEST=N+1:N=N-NN:GOTO5
0
280 CLS:PRINT"ARE YOU SURE YOU W
ANT TO OUIT? (UAIA WILL BE LOST
) YES OR NO?"
290 IS=INKEY$:IE IS="*"THEN 290 EL
SE IF IS="Y" THEN END ELSE 180
300 CLS:INPUT"FILENAME":FS:IFLEN
(FS)>8 THEN 300 ELSE IF PEEK#0N<
000)-68 THEN DN=1 ELSE DN=-1
310 RETURN
    
```

18K

**The Listing: MATCHMAK**

```

1 "MATCH MAKER
2 "BY KEVIN SPEIGHT
3 "COPYRIGHT (C) 1992
4 "FALSOFI, INC.
5 "RAINBOW MAGAZINE
10 MN=50:MC=20:OIM$(MN,MC),O$(M
C),O(MC):GOTO180
20 CLS:INPUT"HOW MANY CRITERIA":
C:IF C<1OR C>MC THEN20 ELSE FOR
Y=1TO C:PRINT:PRINT"CRITERION #
Y:":LINEINPUTQ$(Y):INPUT"RELATIVE
WEIGHI (ENTER=1)":O(Y):IF O(Y)=0
THEN Q(Y)=1
30 NEXTY
40 CLS:INPUT"NUMBER OF PEOPLE":N
:EN/2<>INT(N/2)THEN INPUT"PLEAS
E LEAVE SDMEONE OUT-AN EVEN
NUMBER IS NEEDED <ENTER>":PS:GOT
O40 ELSEIFN<1OR N>MN THEN40 ELSE
PRINT:ST=1
50 FORX=ST TO N:CLS:PRINT"PERSON
#X:":NAME:"":LINEINPUTS$(X,1):
PRINT:PRINT"ENTER DATA:":FORX=11
O C:PRINTQ$(Y):INPUTXX:S$(X,Y+1
)=STR$(XX):NEXTY:PRINT:NEXTX:GOT
O180
60 IFN>1 THENCLS:PRINT"OUTPUT IO
SCREEN OR PRINTER?" ELSE180
70 IS=INKEY$:IF IS="P" THEN DV=2
ELSE IF IS="S" THEN DV=0 ELSE 7
0
80 CLS:PRINT#DV,"PAIRINGS":PRIN
T#DV:A=T
90 IF LEFT$(S$(A,1),1)=-* THEN
IE ACN THEN A=A+1:GOTO90 ELSE 15
0 ELSE B=A+1:FL=0:PRINT#DV,S$(A,
1):".":
100 IF B>N THEN 140 ELSE IF LE
T$(S$(B,1),1)=-* THEN R=B+1:GOT
O100
110 FORX=2TO C+1:D=0:D=ABS(VAL(
    
```

```

S$(A,Y)*O(Y,1)-(VAL(S$(B,Y,1))*O
(Y,1))+0:NEXT Y
120 IF FL=0 THEN BD=0:CD=B ELSE
IF O<BD THEN BD=0:CD=B
130 FL=1:B=0+1:IE B<N THEN 100
140 PRINT#DV,S$(CO,1):S$(CO,T)=
    
```

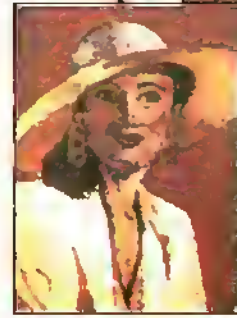

New Clear-screen continued from Page 1

portion (from \$5FFFF through \$7FFFF) is used. The three 128K portions below this in the memory map are *duplicates* of the top portion. In addition, the top 64K of the upper 128K portion is the default memory area assigned to the 6809 at power-up (in both 128K and 512K systems). Therefore if you turn on a 128K CoCo 3 and enter POKE

\$A0E00, 23, LPEEKs to \$70E00, \$50E00, \$30E00 and \$10E00 would all return a value of 23.

GIME registers \$FFA0 through \$FFA7 tell the computer which of the available 8K blocks are needed and in what order they appear in the 6809's 64K address space. The register locations correspond to the 6809's 64K virtual address space as shown in Figure 2.

In each of the registers shown in Figure 2 there can be a six-bit value (\$00 to \$3F) that tells the computer to which of the sixty-four 8K blocks that register should point. For instance, to map Block \$1C (physical memory) into the virtual space from \$6000 through \$7FFF, you would store \$1C into Address \$FFA3. Some of the more important memory areas, along with their associated block numbers, are shown in Figure 3.

The programs in listings 2 and 3 map the Hi-Res text screen into the addressable 64K space in lines 270-280 and 240-250, respectively. The code to do this is as follows:

```

LDA #936 HI-Res Text Block
STA $FFA1 GIME Reg. Block 2
After this code is executed, both programs use addresses in the range $2000 through $3FFF when "talking" to the Hi-Res screen. As stated earlier, this is the range pointed to by the GIME register at Address $FFA1.
The ANDCC instruction (lines 210 and 180, respectively) is used to turn on the CoCo 3's interrupts — the programs use interrupts as a timer.
Like the program in Listing 1, the programs in listings 2 and 3 use two ORG instructions. However, rather than trapping the CLS command, the latter programs hook the WIDTH command (which traps the CLS) located at Address $F68F in Super Extended BASIC.
    
```

Running the Programs

Enter each listing and assemble it to disk with EDTASM, using /AO and whatever other switches you want. Before loading any of the assembled programs, make sure

There are many other uses for the little tricks presented here and for the extended RAM-addressing capabilities of the CoCo 3. The Hi-Res text screen is easy to work with, and you can modify other commands

Block	Function	Physical Address
\$34	HGET/INPUT buffer	\$68000 - \$69FFF
\$36	Hi-Res text-screen RAM	\$6C000 - \$6DFFF
\$3C	Extended BASIC interpreter	\$78000 - \$79FFF
\$30	Color BASIC interpreter	\$7A000 - \$7BFFF
\$3E	Disk BASIC interpreter	\$7C000 - \$7DFFF
\$3F	Super BASIC, GIME, I/O interrupts	\$7E000 - \$7FFFF

Figure 3: Some Important CoCo 3 Memory Blocks

you are in the proper screen mode. SNAKE works only on the 32-column screen, while STACKER is intended for the 80-column screen. The program in Listing 3, FA0ER, is designed to work with both the 40- and 80-column screens. Enter the appropriate WIDTH command before loading any of the programs listed here.

Also, *do not* enter EXEC after loading any of the programs. The patch is already in place after loading, and you need only enter CLS to see the new routines in action. You can enter CLS from the command line or call it from within a BASIC program. If you really want to use EXEC, you can remove the CLS traps before assembling the programs.

Finally, if you enter WIDTH40 or WIDTH80 on the 32-column screen after one of the programs is installed, you may find the CoCo 3 appears to lock up. In fact the computer is faithfully executing the routine — you just can't see it. Similarly, if you are on a Hi-Res screen and you change the screen width, the new routine is executed before the width is changed.

to suit special needs. With a little imagination, you can write some really interesting and amazing programs. For more information about the Hi-Res screens and the CoCo 3's GIME/MMU, refer to the CoCo 3 Service Manual and the manual that comes with the computer itself. Also check out Rick Adams' "GIME Power" (THE RAINBOW, March 1989, Page 14).

I want to thank Mike Pepe for the help he gave me on these programs and extended RAM addressing. Without him, this article would not have been possible. Thanks, Mike.

Jason Dessel is an engineering student who has written several programs for the CoCo (including a warehouse-inventory and -billing program for a large distributing company). In his spare time, Jason enjoys philosophical conversation, exercise and music.

**TIP**



When programming with a computer, it is often necessary to convert between the decimal numbering system and hexadecimal. And the CoCo provides an easy way to perform these conversions. To convert a Hex value to decimal, enter ?&Hexxx, replacing the four X's with the Hex digits. (The ? symbol is shorthand for PRINT.) To convert from decimal to Hex, enter ?HEX\$(yyyy), where yyyy is the decimal number you want to convert.

# The 68XXX Machines

The most in-depth information vehicle for the new 68XXX machines.

"68 triple X" is especially for you that are seeking a high-level approach to your computer activities.

Each issue has programs, utilities, language examples, and hardware and software reviews. Writers include Ron Anderson, Bob van der Poel, J Scott Kastern and many others; plus thought provoking comments by Rush Caley,

Operating systems covered include OS-9/68K, SK-DOS, REX, Minix and OS-9/6809. Languages include lots of 'C', assembler, Whimsical, some Basic09 and others. You have already missed the first 12 issues, don't miss another. Checks and major credit cards accepted. First issue FREE - phone or write for 13 issues..

1 year / 2 years  
 USA, \$14.75 / \$27.50, 1st class  
 CANADA, 16.75 / 31.50, 1st class  
 OTHERS, 17.00 / 32.00, Surface

The 68xxx Machines  
 RD 1 Box 375  
 Wyoming DE 19934  
 phone 302/492-8511

# JWT Enterprises

**Optimize Utility Set 1:** Optimize your disks by eliminating fragmented files and compacting your directories for faster file access. Running time averages one hour. Also includes a utility to assess file fragmentation and directory fragmentation as well as excess directory padding. Can work in conjunction with Burke & Burke's repack utility. Look for upcoming review in *Rainbow*. \$29.95; Foreign Postage, add \$3.00

**Optimize Utility Set 2:** Contains two programs to check the integrity of your disks. Detect and correct any directory or file structure errors. Run periodically and before any optimizations to insure the reliability of your data. Look for upcoming review in *Rainbow*. \$19.95; Foreign Postage, add \$3.00

**Optimize Utility Set Pac:** Combination of both optimize sets. Purchasers of the *Optimize Utility Set 1* can upgrade for \$9.95 with proof of purchase. \$39.95; Foreign Postage, add \$4.00

**Nine-Times:** Each issue contains: 9 helpful and useful programs to help build your OS-9 library • Instructions, examples, and samples of Basic09 procedures and subroutines to help with your own programs and your understanding of Basic09 • C programs and programming examples • Hints, Help columns, and Informative articles to advance your knowledge of OS-9 • Supplied totally of 5.25" disk • Bonus manual sent to each new subscriber for help in getting *Nine-Times* up and running, as well as tips on using it with a ram disk or hard disk • All graphic/joystick interface for ease of use. **One Year Subscription, \$34.95; Canadian Postage, add \$1.00; Foreign Postage, add \$6.00**

**BACK ISSUES:** Available for the May 1989 through November 1991 issues. Please write for information on Back Issue contents. \$7.00 each; Foreign Postage, add \$2.00 each

**Magazine Source:** Due to many inquiries, the source code for the magazine graphic presentation shell is being provided as an informational tool. Included is the actual Basic09 source code and compiled modules on disk, as well as documentation and a printed copy of the source code. \$25.95; Foreign Postage, add \$5.00

JWT Enterprises  
 5755 Lockwood Blvd.  
 Youngstown, OH 44512

Technical Assistance & Inquiries:  
 (216)-759-7694



Foreign postage includes U.S. Postage and Canada. All products for 1991. Limit 2. Sorry, no C.O.D.'s or credit cards. Foreign & Canadian orders, please use U.S. money orders. U.S. checks, allow 6-8 weeks for receipt of first issue/back issue.

CoCo 3 Disk

*Editor's Note: The programs shown in listings 1, 2 and 3 are "segmented." This means that, when assembled, the programs are stored in various locations in the CoCo 3's address space. Since the CoCo cannot handle segmented programs on tape, the following three programs are not included on this month's RAINBOW ON TAPE. They are, however, included (along with source code) on this month's RAINBOW ON DISK.*

Listing 1: SNAKE

```
00100 *****
00110 * 32 column text snake! *
00120 * By: Jason Dessel *
00130 * 3/18/88 *
00140 *****
00150
00160 ORG $A928 ORG at "CLS" location
00170 LBRA $1DA Branch to prg.
00180
00190 ORG $1DA Org. our program
00200
00210 LDB #96 Space character
00220 LDY #1200 Distance from start to end
00230
00240 RSTART LDX #1600 End of screen
00250 LEAY -1,Y Decrement Y 1
00260 BEQ ENDEX
00270
00280 DOWN LBA -.X Load A w/ char. before
00290 CMPX #1400 First character?
00300 BLO RSTART If so, restart
00310 LEAX 1,X Add one to scrn locatlon
00320 CMPX #15FF End of screen?
00330 BHI CUT If so, End!
00340
00350 * **Main Loop** *
00360 STORE STA .X Store char. one space over
00370 LEAX -1,X Move back one
00380 STB .X Store space right before
00390 BRA DOWN Move next char down one
00400 CUT LDX #15FF Load X with end of scrn
00410
00420 BRA STORE Restart LDOP
00430
00440 ENDEX LDY #1400 Return to top
00450 STY $88
00460 RTS
00470 END $E00
```

Listing 2: STACKER

```
00100 *****
00110 ** STACKER - CLS patch **
00120 ** By: Jason Dessel **
00130 ** June 1988 **
00140 *****
00150 ** Special THANKS to **
00160 ** Mike Pepe **
00170 *****
00180
00190 ORG $F6BF WIDTH B0 command
00200 PSHS A,B,X,Y,U
00210 ANDCC #1AF
00220 JSR $01DA Jump to our clear subr.
00230 PULS A,B,X,Y,U
00240 BRA $F6A2 To end of CLS command
00250
00260 ORG $01DA
00270 LDA #136 Page memory [HI-RES text scrn]
00280 STA $FFA1
00290
00300 LOB #25 24 lines on scr. + one extra
00310 STB LINE (to clear chars.)
00320
00330 LOOP1 LOB LINE
00340 LDA #160 Each line is 2 bytes [80*2-160]
00350 MUL
00360 TFR D,X
00370 LEAX 1200,X Go to next line to be moved
00380
00390 BSR MOVE Go to MOVE subr.
00400
00410 LDB LINE Load B with # lines left
00420 DECB Decrement # lines left
00430 STB LINE Store new amt lines
00440 ISTRB Are there any more lines?
00450 BNE LOOP1 If so, branch back to loop
00460 LOX #1200
00470 BSR MOVE Branch to move
00480
00490
00500 LDX #1200 Top of HI-RES screen
00510 STA $FE00
00520
00530 RTS
00540
00550 MOVE LDB #80
00560 LDY #1200
00570 MOV100 LDU .X Load U with X
00580 STU 160,X Store char. on next line
```

```
00590 STY .X++
00600 DECB Decrease line counter 1
00610 BNE MOV100
00620
00630 SYNC
00640
00650 CMPX #1200+(130*160)
00660 BKE MDVE Go if not end
00670
00680 RTS
00690 LINE FCB 0
00700 END $0E00
```

Listing 3: FADER

```
00100 *****
00110 ** FADER - CLS patch **
00120 ** By: Jason Dessel **
00130 ** June 1988 **
00140 *****
00150
00160 ORG $F6BF WIDTH 80 command
00170 PSHS A,B,X,Y,U
00180 ANDCC #1AF
00190 JSR $01DA Jump to our clear subr.
00200 PULS A,B,X,Y,U
00210 BRA $F6A2 To end of CLS command
00220
00230 ORG $01DA
00240 LDA #136 Page memory [HI-RES text scrn]
00250 STA $FFA1
00260 GETDAT LDX #COLDRS Get color table in X
00270 INCR LDA .X+ Get color, increment
00280 CMPA #99
00290 BEQ ENDEX End of cycle?
00300 STA $FFBB Change to current palette
00310 PAU010 LDY #3500 Set pause value
00320 PAU020 LEAY -1,Y Decrement Y
00330 BEQ INCR
00340 BRA PAU020
00350 ENDEX LDX #1200 Clear Screen subr.
00400 LDY #1200
00410 CLR020 STY .X++ Store color & attr (2 bytes)
00420 CMPX #1200+(2*80*24)
00430 BNE CLR020
00440 BRA DONE
00450 ** COLDR TABLE **
00460 ** RGB colors! **
00470 COLDRS FCB 1 Dark Blue
00480 FCB 5 Dark Purple
00490 FCB 8 Dark Medium Blue
00500 FCB 9 Brilliant Blue
00510 FCB 15 Bright Blue
00520 FCB 25 Light Med. Blue
00530 FCB 28 Light Gray/Green
00540 FCB 58 Pale Green
00550 FCB 26 Light Blue/Green
00560 FCB 18 Brilliant Green [default]
00580 FCB 99
00590 DONE CLRA
00600 STA $FFBB Change to black FG
00610 LDA #139
00620 STA $FFA1 Return to normal
00630 RTS
00640 END $E00
```



New Features

Many new features have appeared over the past several months. I'll describe some of the more useful additions as well as some of the older features people have recently discovered.

If you receive a high volume of mail, you may find yourself unable to keep up. An easy way to keep track of important messages, beyond using folders, is to use Mail's MARK command. All marked messages appear in the directory listing prefixed with an asterisk. You can also use the new SELECT command to see only selected messages.

When you type DIR, you see a directory of the current Mail folder. The name of the listed folder is printed at the right margin of the screen on the first line of the directory listing. The listing shown in Figure 1 is a directory of my MAIL folder.

The current folder always defaults to MAIL if you do not have new mail when you enter Mail. If you do have new mail, the folder defaults to NEWMAIL. Notice above that I have three marked messages in MAIL: 6, 7, and 10.

If you want to read only marked messages — which is useful when you have quite a lot of messages in one folder — you can do the following:

```
MAIL> select /marked
3 messages selected

MAIL> dir
MAIL
# From Date
Subject
* 1 BOSTB:EM1WD 9 NOV
-1991 ELM v2.3 PL11 can't reply
to me.
* 2 BOSTB:EM1WD 9 NOV
-1991 My specifics
* 3 BOSTC:GREGJ 13 JAN
-1992 Some interesting results
```

Now we see only those messages in which we are most interested. The SELECT

command is useful for far more than just selecting folders and marked messages, however. Let's say you remember receiving a message from Jason Bucata, but you don't remember when or what the subject was. You just remember that the message arrived during December 1991. You could enter

```
MAIL> select /before=1-Jan-1992 /since=1-Dec-1991 /from=jhucata
```

and a directory would show all messages you received from Jason during December 1991. You can also search by subject:

```
MAIL> sel /sub=re
```

4 messages selected

```
MAIL> dir
```

```
MAIL
# From      Date
  Subject
1 BOS2A::DODGECOLT  8-JAN-1991  RE: ar
2 BOS1C::GREGL     11-APR-1991  RE: Delphi bureau delayed
* 3 BOS1B::ENTWO    9-NOV-1991  ELM v2.3 PL11 can't reply to me.
```

```
* 4 BOS1C::GREGL     13-JAN-1992  Some interesting results
```

The /SUBJECT qualifier selects all messages containing the given substring anywhere in the subject of the message, in any combination of uppercase and lowercase characters. If there are any blanks in the string for which you want to search, you must surround the string with quotation marks. You can also select just those messages to which you have replied, or those to which you haven't replied. Yes, just as you would expect, if you enter

```
MAIL> select /replied
```

you will select only those messages in the current folder to which you have replied. If you want to see those messages to which you have not yet replied and received since January 15, 1992, you can specify:

```
MAIL> select /noreplied /since=15-Jan-1992
```

So, as you see, you can combine these qualifiers to be as specific as you desire. Once you have selected the messages you want to see, you can use all of the normal Mail commands. Your selection lasts until you use the SELECT command again, or

#	From	Date	Subject	MAIL
1	BOS2A::DODGECOLT	8-JAN-1991	RE: ar	
2	BOS1C::GREGL	11-APR-1991	RE: Delphi bureau delayed...	
3	BOS1B::D7ESRTIMOTHY	6-MAY-1991	kermit (dial)	
4	BOS1A::BILLBETSSERT	12-OCT-1991	KBCOM for the MM/1	
5	BOS1B::TMMKIENTZLE	4-NOV-1991	Term program ravings...	
* 6	BOS1B::ENTWO	9-NOV-1991	ELM v2.3 PL11 can't reply to me.	
* 7	BOS1B::ENTWO	9-NOV-1991	My specifics	
8	BOS1C::GREGL	18-NOV-1991	VT100 Emulations	
9	BOS1A::MIWRIGHT	7-DEC-1991	KBCOM and gshell	
* 10	BOS1C::GREGL	13-JAN-1992	Some interesting results	

Figure 1: Output of Online DIR Command

until you leave Mail. For full information on the SELECT command, enter HELP SELECT in Mail.

**Editing Files**

Many people who have used a VAX before are used to the command-line and full-screen editing available. If you call Delphi directly (you don't use SprintNet or Tymnet), you can use these features; however, if you use a packet-switching network like Sprintnet or Tymnet, you normally cannot. The reason is that characters such as backspace, delete, and escape sequences are interpreted at the local network node, not at Delphi. (This is called "local echo" because characters you type are echoed

from the local network node, not from Delphi.)

To set up host echo, where each character you type travels all the way to Delphi before it is echoed back to you, enter

```
OS9> /echo host
OS9> /save
```

These commands change your settings permanently to host echo. You will notice a much slower response to your keypresses with host echo, so you may want to try it (or turn it on and off within an online session). To turn host echo on for the current login only, you can type /ECHO HOST without using /SAVE. To return to local echo, enter

**Outstanding OS9 Software!**  
For your CoCo or MM1 compatible computer!

**We will beat any advertised price!**

**Brand New Program!**

**Sink the Armada™** This month's best buy! Imagine playing Battleship where some missiles are dumb! Includes point & click interface and beautiful 3-D screen objects! Req. CoCo 3 or 100% compatible w/256k, RGB monitor, disk drive, mouse/joystick, OS9 Level 2 & Windini. \$17.95.

\*\*\*\*\*

**TV for OS9 Level 2™** View one file while working on another. Pages/scrolls back & forth through text files. Fits files in any window. Req. CoCo 3 or 100% compatible w/128k, disk drive, & OS9 Level 2. \$8.95.

**High Finance™** The BEST CoCo financial analysis software! Req. CoCo 3 or 100% compatible w/128k, disk drive, mouse/joystick, & OS9 Level 2 w/Windini. \$24.95.

**MV Banner™** Multi-View banner program! Req. CoCo 3 or 100% compatible w/256k, OS9 Level 2, disk drive, Multi-View, 80 col. monitor, & mouse/joystick. \$18.95.

**WP Shcl™** Multi-View style interface from which you access any OS9 text editor, formatter, & spelling checker (that you supply). Req. CoCo 3 or 100% compatible w/256k, disk drive, OS9 Level 2, & Windini. \$20.95.

**OS9 Calendar Utilities™** Display your schedule automatically on start up & perform routine tasks on Gcal data files. Use w/Gcal, or alone. Req. CoCo 3 or 100% compatible w/128k, disk drive, & OS9 Level 2. \$14.95.

**Bank™** phone list/dialer & scheduling system! Req. CoCo 3 or 100% compatible w/512k, disk drive, OS9 Level 2, & Windini. Modem req. to use phone dialer. \$34.95.

**OS9 Budget System™** Track & analyze financial transactions & prepare reports. Req. CoCo 3 or 100% compatible w/256k, disk drive, & OS9 Level 2. \$19.95.

**OSK Versions Available!**

**OS9 Level 2 Game Pack™** Sea Battle, Minesfield, Knights/Bridge, CoCoHeb, & Dice Poker. Beautiful color graphics & mouse support! Req. CoCo 3 or 100% compatible w/256k, disk drive, & OS9 Level 2. \$32.95.

OSK version req. MM1 or 100% compatible computer, disk drive, OS9-68000, & mouse/joystick \$47.95!

**Variations of Solitaire™** Pyramid, Klondike, Spider, Poker, and Canfield. Beautiful color graphics & mouse support! Req. CoCo 3 or 100% compatible w/256k, disk drive, OS9 Level 2, & mouse/joystick \$32.95.

OSK version req. MM1 or 100% compatible computer, disk drive, OS9-68000, & mouse/joystick \$47.95!

\*\*\*\*\*

**Send for free catalog!**

\*\*\*\*\*

All products carry the Rainbow Certification Seal. VISA and MasterCard orders accepted. Please add \$2.50 (U.S.) or \$5.00 (foreign) for shipping and handling. Colorado residents please add applicable sales tax. Prices subject to change without notice.

**MV Systems**  
P.O. Box 818  
Arvada, CO 80001-0818  
(303) 420-7777

**The OS9 and Multi-View Specialists!**

**SOLITAIRE CARD GAMES**

**DuoDeck:** Double Deck Solitaires. Play Sly Fox or Windmill - both games of skill. \$19.95

**Classic Solitaire:** Klondike, Canfield and Pyramid on one disk for just \$14.95

**La Belle Lucie:** A true game of skill. \$14.95  
All three play on 128K CoCo3, with joystick and disk.

**SAVE \$10.00. BUY ALL THREE FOR \$40.00**

**Deception Path**  
Spend time with your family navigating the ever-shifting maze. Play competitive or non-competitive. 128K CoCo3 \$19.95

Eversoft Games now sells more than software. Introducing the most innovative calling card in America:

**AmeriVox**  
America's New Voice in Calling

**Save 50% or more on your present telephone card**

Unlike AT&T, MCI or Sprint, there is NO SURCHARGE with the AmeriVox calling card. On a 3 minute call, distance 1,000 miles, 8am-5pm, you save 49%-52% when using the AmeriVox card.

**Build equity in a calling card?**

You bet! No other phone company has anything like it! The more you use AmeriVox the lower your rates will be and the more money you'll save. No time limits are imposed to qualify for lower rates, and no minimums to meet to keep the lower rate. Once you have it, it's yours.

Call from anywhere to anywhere at anytime in the contiguous forty-eight United States. Across the state or across the country you save on every call. AmeriVox is good for interstate, intrastate and intralata (where permissible) calling. Business or residential use.

Please write for brochure and pricing information.

Checks, Money Orders, MasterCard & Visa \$2.50 S&H  
COD \$2.00 extra. WA addresses add 8.2% sales tax. Software submissions invited

**(206) 653-5263** Eversoft Games, Ltd  
P.O. Box 3354  
30 day money back guarantee Arlington, WA 98223

**ADVENTURE SURVIVORS!** L.E. Padgett  
This is your newsletter! Only \$3 per year. Reviews, solutions, and more! 24 Perthshire Dr.  
Call or write for details. Peachtree City, GA 30269  
(404) 487-8461

/ECHO ECHO. You can enter either command from anywhere on Delphi that accepts slash commands — that is, anywhere but in Mail.

You may now be sitting there asking, "Yeah, but what does host echo do for me?" If you use host echo, you can use EDT in full-screen mode. EDT? Yes, EDT is one of the two editors you can select as your online editor. If you are editing a forum message, you can type /EDIT to enter your chosen editor. If you now type C (for Change mode), you will enter full-screen mode where the arrow keys move the cursor around the screen. When you are finished editing, exit by pressing ^Z (CTRL-Z) and then enter EXIT at the prompt.

Next month I'll explain EDT and Change mode in more detail. I'll also cover some useful tricks you can perform with the online editors.

**New Conference Features**

Jason Bucala (JBUCATA) brought to my attention new features of the /WHO command that work in Conference. The new options are:

- /WHO A Available list only
- /WHO G Your group only
- /WHO I Idle list only
- /WHO N Nonprivate groups only
- /WHO P Private groups only

People are listed as idle if they are sitting at the CONFERENCE prompt and have not yet entered a conference group. A private group is a conference group that you must be invited to join before you can enter. Generally, any conference group with "Private" in the title is a private group. These options cause /WHO to list only people who meet the selection.

**New Uploads**

In the OS-9 SIG General Information database, several people contributed news bulletins describing G-Windows — a window driver used in some OS-9/68000 machines. Steve Adams (STADAMS), the author of G-Windows, released a description of the G-Windows library functions. Robert Kemper (BOBKEMPER) uploaded several useful files: a full listing (including descriptions) of the contents of each OS-9 database. Because of the ongoing database reconstruction, these files may not be totally accurate. But these files will at least help you find what is online. Erich Schulman (ESCHULMAN) contributed a list of 10 humorous commandments for C programmers to follow.

In the Applications (6809) database, Homer Meyer (MEYER01) posted a C rewrite of Kevin Darling's gmap utility. Robert Coulter (RDCOULTER) uploaded a utility that sets the right mouse as a Hi-Res mouse, allowing flexibility in your startup file. Chris Serino (CSERINI) released the first version of his phone handler. This application allows phone messages to be stored for many users.

In the Telecom (6809) database, Philip Brown (THEFFRET) uploaded Brian Marcotte's VT100 terminal emulator. Alan Sheltra (ANIMAJIK) released a demo version of the STG BBS package. Mark Steiner (MODEL299) uploaded into Device Drivers a Disk BASIC program that patches your OS-9 boot (not the OS9Boot file), allowing you to modify the boot screen's colors. Brian Steward (STEFWARD) contributed Bob Santy's patch for RHF that adds a new status call as well as the ability to undelete files.

The Programmers Den found many OS-9/68000 versions of popular GNU programs such as lex (Lexical Analyzer), gawk (GNU's awk), and bison (a version of yacc

— Yet Another Compiler Compiler). In the 68K-OS9 Database, Brian Wright (POLTERGEIST) uploaded a compilation of EFFE (the European Foundation For OS-9) utilities. The archived files in this group are huge, so you may want to check the index to these archives, which is also located in this database.

In the CoCo SIG General Information database, Carl Boll (CBI) uploaded information about the Glenside Color Computer Club, a Chicago club supporting our favorite computers. Joe Sannucci (SANNUCCI) released the latest version of Roger Taylor's *The Projector* into the CoCo 3 Graphics database. This program displays many different graphics formats.

In the Utilities & Applications database, Richard McNabb (RICKMAC) contributed a utility that displays two disk directories and allows copying files between them as well as many other disk maintenance features. Denver Page (DENPAG) also released a disk utility. Joe Sannucci (SANNUCCI) uploaded SSN.BAS, which explains how Social Security numbers are distributed; if you've ever wondered, the answers are now at hand. If you want to find where an unfamiliar long distance number is located, you'll be interested in John Lentz's (COCOJOHN) DIRASST.BAS program. John also uploaded Jeff Kilsdonk's GIFTAG.BAS, which creates simple labels suitable for gifts.

Danny Fye (DFYE) uploaded several CEBBS (a CoCo BBS) games and utilities. Joe Sannucci (SANNUCCI) released the latest version of Wayne Laird's list of BBSs supporting the CoCo and OS-9. This list now includes phone numbers of BBSs that carry Fidonet echos.

*Eddie Kuns is pursuing a doctorate in physics at Rutgers University. He lives in Aurora, Illinois, and works as a programmer and researcher at Fermilab. Eddie is the OS9 Online database manager; his username is EDIEKUNS.*

**OS-9 SIG**

**General Information**

- TC70 KIT INFORMATION
- FHOOGG Frank Hogg
- G-WINDOWS LIBRARY DESCRIPTION
- STADAMS Steve Adams
- MOTOROLA FREEMARE BBS
- WALKFROG Greg Walker
- LOW-COST RAINBOW AD INFO
- DSRTFOX Francis Swygett
- NEW COMPANY FORMATION
- NIMITZ David Graham
- ALLFILES - DESCRIPTIONS 18/12/91
- BOBKEMPER Robert Kemper
- THE COUPLER
- JSUTEMEIER Jim Sutenecier
- LOW-COST ADS FOR RAINBOW
- DSRTFOX Francis Swygett
- OS-9 PROGRAMMER'S JOURNAL #3
- FARTHER Shawn Driscoll
- C PROGRAMMER'S TEN COMMANDMENTS
- ESCHULMAN Erich Schulman
- TC70.FLP: V4 FLOPPY DRIVER INFO
- FHOOGG Frank Hogg
- GWINDOWS ANNOUNCEMENT FROM FHL
- FHOOGG Frank Hogg
- GWINDOWS ANN. FROM DELMAR CO.
- EDFIMAR Ed Grevick

**Applications (6809)**

- STDHELL V1.00: SHELL MENU ENV.
- ILF'ISIONIST Michael Graffan
- DISKOPY 2.1: DISK COPYING UTIL.
- DKINDBERG Darren Kindberg
- URLZH3: EXTRACT LZH ARCHIVES
- COGITATR Norman Rheanme
- DESKMATE3/ANY VDG + HIRES MOUSE
- RICKMAC Richard McNabb
- RUN DM3 APPS FROM MULTI-VUE
- RICKMAC Richard McNabb
- PICK6 LOTTD HELPER
- BOBKEMPER Robert Kemper

- OS9STAT: OS9 STATISTICS PACKAGE
- HERMAN Chris Suckland
- GPMP: SHOW GET/PUT BUFFER MAP
- MEYER01 Homer Meyer
- MENU: L2 MENUING SYSTEM
- RICKULAND Rick Liland
- GSORT: DIR. SORT FOR MULTI VUE
- WOAY Jim Manin
- PRINTFORM 2.0: PRINTOUT FORMATER
- WOAY Jim Manin
- MOUSE: JOYSTICK TO HI-RES MOUSE
- RDCOULTER Roben Coulter
- DISCAN V3.1A - DETECT BAD SECTORS
- DIGEN40 Eugene Anderson
- VSHLL FOR MULTI VUE
- DKINDBERG Darren Kindberg
- DC-MESSAGE V2.0
- CSERINO Cliris Serino
- BWUTIL: SET FILE TIME/DATE
- RPIERCE Robert Pierce

**Telecom (6809)**

- VT100: SMALL TERMINAL PROGRAM
- THEFFRET Philip Brown
- STG NETWORK/BBS DEMO RELEASE
- ANIMAJIK Alan Sheltra
- ICON AND AIF FOR SUPERCOMM 2.1A
- ESCHULMAN Erich Schulman

**System Modules (6809)**

- OS9 BOOT SCREEN COLOR PATCH
- MODEL299 Mark Steiner
- DISTO (6551) MOD FOR DCO
- TRIX John Farrar
- RBF3D.AR 1PATCH FOR RBF
- STEFWARD Brian Steward

**Games & Graphics**

- STAR TREK 4096 COLOR IMG PIX
- DEANHOLDER Dean Holder
- BEATLES "BUTCHER COVER" 4096 IMG
- DEANHOLDER Dean Holder
- WIPEOUT: DIGITIZED SOUND FILE
- MODEL299 Mark Steiner
- SGT. PEPPER'S ALBUM COVER (IMG)
- DEANHOLDER Dean Holder
- STAR TREK: RASCAN IMAGES (IMG)
- DEANHOLDER Dean Holder
- ROMAN PILLARS (VF3)
- DONALDDF Leslie Donaldson
- MARINE CORPS EMBLEM (VEF)
- BRWOOLSTRUM Brian Woolstrum

**Music & Sound**

- I WANT YOU: ELVIS SONG (UME)
- HOWARDC Howard Rouse
- NEW GOLDEN OLDIES (UME)
- HOWARDC Howard Rouse
- A MIXED BAG OF SCORES (UME)
- MISHOO Mike Shook
- MERRY XMAS FROM ZOG'S CAVERN BBS
- ANIMAJIK Alan Sheltra
- GEORGE HARRISON SOUND FILES
- DEANHOLDER Dean Holder

**Programmers Den**

- FLEX: GNU VERSION OF LEX
- NIMITZ David Graham
- GAWK: GNU AWK IMPLEMENTATION
- NIMITZ David Graham
- KRAY V1.02 DISASSEMBLERS HELPER
- BOBKEMPER Robert Kemper
- BISON: "YACC" CLONE FROM GNU
- NIMITZ David Graham
- KRAY V1.00 DISASSEMBLERS HELPER
- BOBKEMPER Robert Kemper
- GUIB V1.1: BASIC09 GUI ROUTINES
- EARTHER Shawn Driscoll

**68K-089**

- RAND.C: RANDOM NUMBER FUNCTION
- JSUTEMEIER Jim Sutenecier
- TTY/PTY IMPLEMENTATION (UNIX-LIKE)
- THEFFRET Philip Brown
- WTPY: SET WINDOW TYPE ON MM/I
- COMPFR Glen Hathaway
- STICKY - MAKE OSK MODULES STICK
- JOELHEGBERG Joel Hegberg
- TC70 TERMLIB ENTRY
- ORYANC Bryan Clingman
- NEW STANDARD FONTS FOR MM1
- MARRKGRIFITH Mark Griffith
- TEXT FILE CONVERSION FILTERS
- VAXELF John Donaldson
- PEARLS: RANDOM MESSAGE PRINTER
- PAGAN Stephen Curville
- BALLS: MULTI-COLOR BALLS
- L'OMPER Glen Hathaway
- RANDOM NUMBER FUNCTION FOR C
- VAXELF John Donaldson
- EFFO PD DISKS (OSK)
- POSTERGEIST Brian Wright
- PD0EM: PALETTE DEMO FOR MM1
- COMPFR Glen Hathaway
- COLORS: COLOR DEMO FOR MM1
- L'OMPER Glen Hathaway

- AUTODOC: AUTOMATIC C DOCUMENTER
- NIMITZ David Graham
- PARANOIA - OSK GAME
- POLTERGEIST Brian Wright
- VGIF2: GIF VIEWER FOR VGA OSK SYS
- WHIAMBLEN William Hamblen
- SETTERM T.2T: SET TERM ENV.
- BRIANWHITE Brian White
- OSK SYSTEM UTILITIES
- VAXELF John Donaldson
- BOOTS: KEEP TRACK OF # OF BOOTUPS
- JOELHEGBERG Joel Hegberg

**Tutorials & Education**

- CUSTOM MULTI-VUE BOOT DISK
- RICKMAC Richard McNabb
- DESKMATE 3 HELP / ADD LINEFEEDS
- RICKMAC Richard McNabb
- FLOPPY DRIVE CONFIGURATIONS
- BOBKEMPER Bob Kemper

**COCO SIG**

**General Information**

- GLENSIDE COCO CLUB
- CBJ Carl Boll

**CoCo 3 Graphics**

- PINK FLOYD IN CM3
- RICKMAC Richard McNabb
- STAR WARS IN CM3
- RICKMAC Richard McNabb
- JETS IN CH3
- RICKMAC Richard McNabb
- THE PROJECTOR V2.1
- SANNUCCI Joe Sannucci
- PEEK-A-BOD
- SANNUCCI Joe Sannucci
- OLD & NEW TREK CHARACTERS
- SANNUCCI Joe Sannucci
- SOME CM3 PICS
- TIND John Tindall

**Utilities & Applications**

- TWO DISK DIR/FILE UTILITY
- RICKMAC Richard McNabb
- DISK FILE UTILITIES
- DENPAG Denver Page
- SSN
- SANNUCCI Joe Sannucci
- DIRASST.BAS
- COCOJOHN John Lentz
- GIFTAG.BAS
- COCOJOHN John Lentz
- BOWLING STATS VERSION 5.3
- REDCOAT Don Joyce

**Hardware Hacking**

- MODEM/HULL MODEM COCO CABLES
- LINTEP Martin Simmons
- LS138 / E CLOCK FIX
- MARTYGOODMAN Marty Goodman

**Games**

- SOLITAIRE-3
- SANNUCCI Joe Sannucci
- RUN MIND-ROLL FROM RAM
- RICKMAC Richard McNabb
- STOCK MARKET SIMULATION/GAME
- SANNUCCI Joe Sannucci
- COCOCLUE
- SANNUCCI Joe Sannucci
- DRAGON.ARC
- CELOSI
- CHAUPELMSI
- BLOX.BIN
- SANNUCCI Joe Sannucci

**Classic Graphics**

- MERRY CHRISTMAS FROM KCCOCO
- DFYE Danny Fye

**Music & Sound**

- VAR. SONGS FOR THE CASIO MT-240
- DFYE Danny Fye
- TJUKEBOX
- TMB Terry M. Blackwell
- CHRISTMAS MUSIC
- DFYE Danny Fye

**Product Reviews & Announcements**

- LOW-COST RAINBOW AD INFO
- DSRTFOX Francis Swygett

**Telecommunications**

- DIALER FOR DELUXE RS232 PAK
- EARTH-CASPER Earth Casper
- STAR WRECK GAME FOR CEBBS
- DFYE Danny Fye
- HANGMAN GAME FOR USE WITH CEBBS
- DFYE Danny Fye
- SUPERCEBBS
- DFYE Danny Fye
- COCOS9ER #6
- SANNUCCI Joe Sannucci



# DELPHI — The \$1 per hour online solution!

**DELPHI's 20/20 Advantage Plan sets the standard for online value:  
20 hours for only \$20, for all the services you want!**

- Thousands of files to download.
- Chat lines with hundreds of participants.
- Worldwide e-mail.
- Hobby and computer support groups.
- Multi-player games.
- Local access numbers  
in over 600 cities and towns.

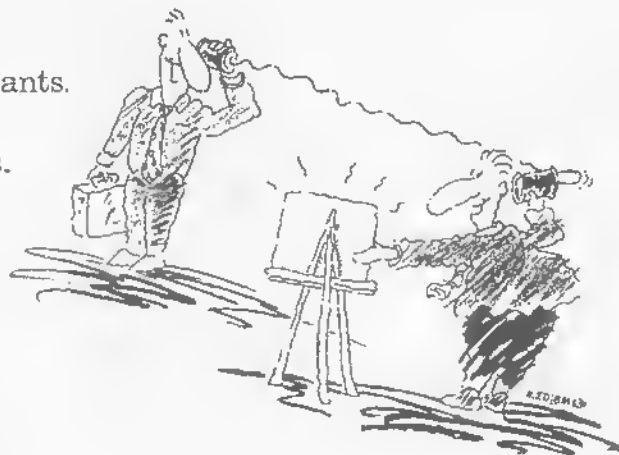

## Trial Offer: 5 hours for \$5!

Try DELPHI at \$1 per hour. Join today and get 5 hours of evening and weekend access for only \$5. If you're not satisfied, simply cancel your account before the end of the calendar month with no further obligation. Keep your account active and you'll automatically be enrolled in the 20/20 plan for the next month.

1. Via modem, dial 1-800-365-4636.
2. When connected, press RETURN once or twice.
3. At *Password*, enter **RB55**

Questions? Call 1-800-695-4005.

Rates apply for evening and weekend access from within the mainland US. There is a one-time enrollment fee of \$19 when you join the 20/20 Advantage Plan. Further details are provided during the online registration.



DELPHI is a service of  
General Videotex Corporation  
1030 Massachusetts Avenue  
Cambridge, MA 02138-5302

800-695-4005 • 617-491-3393

Feature Program

# Get a Bang out of Word Games

**B**eat the Bomb is an explosive word game (pun intended) for the CoCo 3. The program draws a bomb onscreen, lights the fuse, then challenges you to unscramble five words before the bomb goes off.

To play, enter the listing, save it to tape or disk, and enter RUN. When the game first starts, a prompt is displayed and you can choose one of three levels of play: easy, medium or hard. Press the first letter of the appropriate level — *Beat the Bomb* draws your nemesis and displays the first scrambled word.

When you think you have solved the scrambled word, type its letters in the correct order. (If you are a touch typist, you may need to slow your typing speed a bit to allow for the BASIC program loops.) The letters you type appear in the upper-right corner of the screen. If your solution is correct, you need not press ENTER — *Beat the Bomb* automatically displays the next word. Otherwise, press ENTER to delete the attempt and try again. Play continues in this fashion until you correctly solve five words or the fuse burns down.

After you've played a few rounds of *Beat the Bomb*, you'll find you know most of the scrambled words by sight. You can change the words used by entering new words into Array 2. Lines 140 through 380 store 50 words (two words per line) in Z11 through Z1501. To reduce the "cheating" factor, have a friend enter new words for you.

Presented appropriately, *Beat the Bomb* is an excellent educational tool. It helps students quickly establish relationships between consonants and vowels. To target the game for a specific level, change the words used so they all have about the same number of letters.

If you like high-pressure situations, you'll like the way *Beat the Bomb* puts you under the gun!

*John Sava is 14 years old and enjoys programming the Color Computer. He may be contacted at 618 N. Townsend Street, Syracuse, NY 13203.*

```

150 Z$13)="DINOSAUR":Z$14)="BUIL
DING"
160 Z$15)="NUMBERS":Z$16)="DCTDP
US"
170 Z$17)="EASTER":Z$(81)="CHRIST
MAS"
180 Z$19)="THANKSGIVING":Z$(101)=
"SUMMER"
190 Z$111)="WINTER":Z$121)="SPRI
NG"
200 Z$1131)="PUMPKIN":Z$114)="RAI
LROAD"
210 Z$1151)="VIBRATE":Z$1161)="CHE
MISTRY"
220 Z$(71)="SCIENCE":Z$(101)="HI5
TORY"
230 Z$(19)="ENGLISH":Z$120)="HOU
SE"
240 Z$1211)="MULTIPLY":Z$(221)="SU
BTRACT"
250 Z$1231)="DEMAND":Z$1241)="VEGE
TABLE"
260 Z$1251)="ANIMALS":Z$1261)="MAR
ATHON"
270 Z$1271)="DOCTOR":Z$1281)="LI ZA
RD"
280 Z$1291)="CROCODILE":Z$1301)="F
INGERS"
290 Z$1311)="PIRATE":Z$(321)="BREA
TH"
300 Z$1331)="EXAMINE":Z$1341)="HOR
SE"
310 Z$(351)="FLOATING":Z$1361)="LE
ARN"
320 Z$1371)="TELEPHONE":Z$1381)="P
ORCH"
330 Z$(391)="GLDWING":Z$(401)="TRA
IN"
340 Z$(411)="CRACKLE":Z$(421)="GRO
AN"
350 Z$(431)="DREAMING":Z$(441)="BI
RDS"
360 Z$1451)="ORANGE":Z$1461)="NAPK
IN"
370 Z$1471)="IMPORTANT":Z$1481)="W
RITE"
380 Z$1491)="JUNIOR":Z$1501)="MUSC
LE"
390 I=1:FORG=1TOS
400 O=ROUND(50)
410 FORH=1 TO 5:IF O=OIH THEN 4
00 ELSE NEXTH
420 P$1 G1-Z$10:Q(1)=O:1=1+I:NEX
TG:FORG=1TOS:O11=O:NEXTG:I=1
430 FORG=1TOS:FORH=1 TO LENI P$1 G
11
440 V=RRDI LENI P$(G11)
450 FORT=1 TO LENI P$1 G:IF V=D(
T1) THEN 440 ELSE NEXTT
460 T$=T$+MID$(P$(G1,V),11
470 O11=V:1=1+1:NEXTH:P$1 G1+T$
:T$="":1=1:FORU=1 TO LENI P$(G):
O1U1=O:NEXTU:NEXTG
480 H$GREENZ:HCL$6:HCOLDRB
490 H$CIRCLE(155,1151,75
500 H$LINE195,801:215,1001,P$E1,
8
510 H$PAINT197,831,11,8
520 H$PAINT1155,1151,8,8
530 H$LINE(153,01:1158,701,P$E1,B
540 H$PAINT1154,21,7,8
550 H$LINE1190,51:1310,301,P$E1,B
:H$PAINT1192,6,11,8
560 H$GET1(0,0)-(30,81,1
570 H$DRAW$BM10,0:C$UIR1UIRUIR2D
1R1D1R1D1R2UIR1UIR1UIR2D1R1D1R1D
1R5D1L1D1L1O1L2D1L1O1L1D1L2U1L1U
1L1U1L2D1L1D1L1D1L2U1L1U1L15U
1R1UIR1UIR2U5"
580 H$PAINT111,21,1,8
590 H$GET1(0,0)-130,81,2
600 H$PUT1(0,0)-130,81,1:H$PUT(0,51
-130,131,1:X=0:Y=8:R=0:B=1:F=24:
HCOLDR3:HPRINT116,151,"0 E A T":
HPRINT(18,171,"HE":HPRINT116,19
1,"B D H B"
610 HCOLDR8:H$LINE(0,0)-190,25).P
SET,8:H$PAINT1(2,2),11,8:HCOLDR8:H
PRINT11,11,"SOLVED":HPRINT1(7,3)
,B,1
620 AS=INKEY$:IF AS="" THEN 630
ELSE 605UB710
630 H$PUT(138,X)-1168,Y1,2
    
```

```

640 HCOLDR2:HPRINT(12,11),PP$(B)
650 PLAY"T25D1AB"
660 H$PUT(138,X)-(168,Y1,1
670 R=R+1:IF R=ZX THEN R=0:X=X+1
:Y=Y+1
680 IF X=33 AND Y=41 THEN 700
690 GOT0620
700 HCOLDR1:HPRINT(24,2),O$:FOR
N=1TO10:HCOLDR2:HPRINT124,21,P$(
81:PLAY"T200D1CCCCCCCCCCCCC":H
COLOR1:HPRINT124,21,P$(81:PLAY"
T200D1CCCCCCCCCCCCC":NEXTN:HCO
LDR5:HPRINT126,5),"YOU LOSE 11":
PLAY"T5005FFF04FF03FFF02FFF01FF
F":FORN=1TO500:NEXTN:GOT0770
710 HCOLDR2:HPRINT(F,21,AS:O$-O$
+AS
720 PLAY"TI7503CDF"
730 IF AS=CHR$(13) THEN HCOLOR11
:HPRINT1(24,21,O$:HCOLDR2:O$="" :F
-23
740 IF O$=P$(81) THEN FORN=1TO10:
HCOLDR2:HPRINT1(24,21,P$(81:PLAY"
T200D1AAA02AAA":HCOLOR11:HPRINT
24,21,P$(81:PLAY"T200D3AAA04AAD
5AAA":NEXTN:O$="" :HPRINT(12,111,
PP$(81:B=8+1:F=23:GOT0770
750 IF B>5 THEN GOT0770
760 F=F+1:RETURN
770 HCOLOR1:HPRINT(T,T1,"SOLVED
":HPRINT1(7,11),B,2:HCOLDR8:HPRIN
T11,11,"SOLVED":HPRINT1(7,1),B,1
:IF B>5 THEN 830 ELSE 750
780 T$=INKEY$:IF T$="" THEN 790 EL5
E820
790 HCOLDR6:HPRINT11,201,"PLAY A
    
```

```

GAIN":PLAY"TI50TABAB"
800 HCOLOR1:HPRINT11,201,"PLAY A
GAIN":PLAY"TI50TABAB"
810 GOT0780
820 IF T$="Y" THEN 50 ELSE POKE6
5496,0:CLS:END
830 HCOLDR5:HPRINT1(25,51,"CONGRA
TULATIONS":PLAY"T25D10000D0D0D0
3000D04000D05000D":FORN=1TO500:N
EXTN:GOT0780
    
```

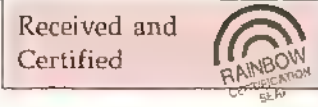

Received and Certified

The following products have recently been received by THE RAINBOW, examined by our staff and issued the Rainbow Seal of Certification, your assurance that we have seen the product and have ascertained that it is what it purports to be.

**leon-Basic09**, a graphic user interface for BASIC09 under OS-9 Level II. *leon-Basic09* allows the programmer to point and click on icons to enter keywords and statements into BASIC09 programs, making programs easier to write and understand. It is also useful for examining programs written by others. Users can list existing programs, and icons will replace the corresponding keywords. Requires a CoCo 3 with at least 256K, OS-9 Level II, and a mouse or joystick. *HAWKSoft, P.O. Box 7112, Elgin, IL 60121-7112, 708-742-3084, \$20.*

**The Bible in CF83 Forth Blocks**, the entire King James Version of the Bible in CF83 Forth blocks on 27 floppy disks. The text is continuous throughout the blocks, without paragraphing or other organization, and is thus suitable for those who want to experiment with developing their own wordsearch programs. Unless a user plans to write his own access programs, use of this product requires CF83 Forth and the CF83 Forth block editor. *BDS Software, P.O. Box 485, Glenview, IL 60025-0485, \$67.50.*

**CF83-6: System Extension Wrds Set**, Use of this program requires the CF83

*Forth* program sold by BDS Software. To keep costs low, the three-page instruction manual is provided on floppy disk. It can be viewed and output to your printer using the reader program, which is also included on the disk. *BDS Software, P.O. Box 485, Glenview, IL 60025-0485, \$5.75.*

**CF83 Paleher**, this program patches the CF83 Forth disk to add an improvement to the Forth word. Requires the CF83 Forth program disk. *BDS Software, P.O. Box 485, Glenview, IL 60025-0485.*

**CoCo Cassette #115**, a variety of programs presented monthly for the CoCo 1, 2 and 3. This issue contains: *Files*, a graphics game in which you must exterminate pesky flies; *Speech Hints*, software for the Speech/Sound Cartridge; *Moumin Wars*, a two-player graphics game; *Super Copy and Kill*, a disk-utility program; *Dani*, a highly addictive block-dropping game; *Maze*, another two-player graphics game; *Disk Directory*, a menu program; *Backup*, a machine-language program that formats and copies 35- or 40-track disks; *Roman Checkers*, an *Outchello* clone for the CoCo; and *Game Quest 2*, a CoCo 3 disk-only graphics adventure game. *T & D Software, 2490 Miles Standish Drive, Holland, MI 49424, 616-399-9168, \$8.*

The Rainbow Seal of Certification is open to all manufacturers of products applicable to the Fandy Color Computer, regardless of whether or not their companies advertise in THE RAINBOW. By awarding the Seal, we certify the product exists — we have a simple copy and have examined it. However, this does not constitute any guarantee of satisfaction. As much as possible, these products will be forwarded to reviewers for evaluation.

CoCo 3

**The Listing:** BEATBOMB

```

1 'BEAT THE BOMB
2 'BY JOHN A. SAVA
3 'COPYRIGHT (C) 1992
4 'BY FALSOFT, INC.
5 'RAINBOW MAGAZINE
40 H$BUFF1,150:H$BUFF2,150
50 POKE65497,0:CLEAR1000:DIMZ$15
01,P$151,PP$151,U1201
60 DN BRK GOT0 50
70 WIDTH32:CLS0:FORN=0T0510:PRIN
TCHR$(1661):NEXTN:PRINT00,"<> A
5 Y":PRINT@169,"< > E D I U N"
":PRIN10342,"< > A R D":
80 PLAY"T2502ABCDGDIACDFG"
90 AS=INKEY$:IF AS="" THEN90
100 IF AS="E" THEN ZX=30
110 IF AS="M" THEN ZX=20
120 IF AS="H" THEN ZX=10
130 CLS3:PRINT00,"PLEASE WAIT. . .
":PLAY"T2502ABCDGDIACDFG"
140 Z$111)="SCHOO1":Z$(21)="COMPU
TER"
    
```

**CBASIC Editor/Compiler**  
The **ULTIMATE** Color Computer  
Basic Compiler!!!

If you want to write fast machine language programs but you don't want to spend the next few years trying to write them in Assembly Language, then CBASIC is the answer!!!

CBASIC is the only fully integrated Basic Compiler and program editing system available for the Color Computer. It will allow you to take full advantage of all the capabilities available in your color computer without having to spend years trying to learn assembly language programming. CBASIC allows you to create, edit and convert programs from a language you are already familiar with Extended Disk Color Basic, into fast efficient machine language programs easily and quickly.

"The most complete Editor/Compiler I have seen for the CoCo..." -The RAINBOW March 1985

CBASIC is a powerful tool for the Beginner as well as the Advanced Basic or M.L. programmer. CBASIC features well over 150 compiled Basic Commands and Functions that fully support Disk Sequential and Direct access files, Tape, Printer and Screen I/O. CBASIC supports ALL the High and Low Resolution Graphics, Sound, Play and String Operations available in Enhanced Color Basic, including Graphics H/GET, H/PUT, PLAY and H/DRAW, all with 99% syntax compatibility.

Specify Coco 1, 2 or 3 Disk \$149.00

**DataPack III Plus V1.1**

**AUTOPILOT and AUTO-LOG Processors**  
**X-MODEM DIRECT DISK FILE TRANSFER**  
**VT-100 & VT-52 TERMINAL EMULATION**

- No lost data even at 2400 Baud on the Serial I/O port.
- 8 Selectable Display Formats, 32/40/64/80 columns
- ASCII & BINARY disk file transfer via XMODEM.
- Directly record receive data (Data Logging).
- VT-100 emulation for VAX, UNIX and other systems.
- VT-100/52 cursor keys, position, PF & Alt. Kbd. keys.
- Programmable Word Length, Parity, Stop Bits
- Complete Full and Half Duplex operation.
- Send full 128 character set from Keyboard.
- Complete Editor, Insert, Delete, Change or Add.
- 9 Variable length, Programmable Macro Key buffers.
- Programmable Printer rates from 110 to 9600 Baud.
- Send Files from the Buffer, Macro Key Buffers or Disk.
- Display on Screen or Print the contents of the Buffer.
- Freeze Display & Review information On line.
- Built In Command Menu (Help) Display.

Supports: Modem-Pak & Deluxe Pak or Serial Port.  
Specify Coco 1, 2, 3 Disk \$49.95

**EDT/ASM III**

EDT/ASM III is a Disk based co-resident Text Editor & Assembler. It is designed to take advantage of the new features of the COCO 3. It has 8 Display formats from 32/40/64/80 columns. The disk also contains a free standing ML Debug Monitor.

EDT/ASM III has the most powerful, easy to use Text Editor available in an Editor/Assembler package for the Color Computer.

- Local and Global string search and/or replace.
- Full Screen line editing.
- Load and Save standard ASCII formatted files.
- Block Move & Copy, Insert, Delete, Overtyping.
- Create and Edit files larger than memory.

The Assembler features include:

- Conditional If/Then/Else assembly.
- Disk Library files up to 9 levels deep.
- Supports standard Motorola directives.
- Allows multiple values in FCB/FDB directives.
- Allows assembly from Buffer, Disk or both.

Specify Coco 1, 2 or 3 Disk \$59.95



**Window Master**  
V3.0

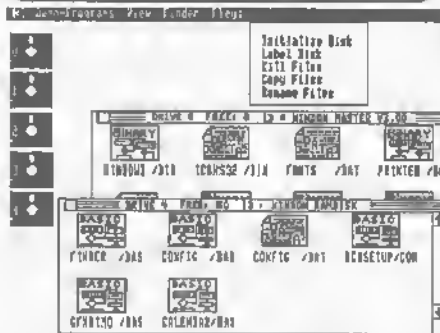

The Ultimate User Friendly Point & Click operating System for your Coco 3. Simple enough even for children to use, just point and click to run programs, select files, do disk or file maintenance or almost any



task you currently do by typing commands. You also get things like a print spooler, Programmable Function Keys, a Buffered Keyboard,

Ramdisk, Serial I/O port and Deluxe Pak support along with Windows, Icons, Buttons, Pull Down Menus, Edit Fields and Mouse functions all in one program. It has multiple fonts in 54 possible sizes and styles, Enhanced Basic Editing and much much more. It add over 50 commands and Functions to Basic to fully support the Point & Click System without OS9.

"...it offers so many features that it is probably underpriced. I recommend this software to all CoCo3 owners." -The Rainbow February 1985

It is completely compatible with existing Basic programs and takes absolutely no memory away from basic. It requires 1 Disk Drive, R.S. hires Interface & Joystick or Mouse.

Includes 128 & 512K Versions Only \$69.95

**"The Source"**

The SOURCE will allow you to easily and quickly Disassemble machine language programs directly from disk and generate beautiful, Assembler Source Code. And 'The Source' has all the features and functions you are looking for in a Disassembler.

- \* Automatic Label generation.
- \* Allows specifying FCB, FCC and FDB areas.
- \* Disassembles programs directly from Disk.
- \* Automatically locates addresses.
- \* Output listing to the Printer, Screen or both.
- \* Generates Assembler source directly to disk.
- \* Built in Hex/ASCII dump/display.
- \* 8 Selectable Display formats 32/40/60/80.
- \* Built in Disk Directory and Kill file commands.
- \* Menu display with single key commands.
- \* Written in Ultra fast machine language.

Specify Coco 1, 2 or 3 Disk \$49.95

**Window - Ware**

**Window Writer**- A point & click Word Processor, powerful formatting capability, works with any printer. On screen italic, bold etc. WYSIWYG..... \$59.95

"Window Writer is a powerful word processor that is fun to use, very user friendly..... The Environment compares favorably to that of Microsoft Windows" - RAINBOW Dec. 1989

**Window Writer/W**- for non W/M owners.....\$79.95

**Window Basic Compiler**- similar to CBASIC...\$99.00

**Window Edt/Asm**- A full featured Assembler...\$49.95

**Font/Icon Editors**- Basic & M.L. versions..... \$19.95

**Advanced Programmers Guide**-.....\$24.95

**The Memory game**- Concentration game .....\$19.95

**Desk Accessory Pak**-7 resident programs .....\$39.95

**Deluxe Terminal**

**A Completely New and Easy to use Terminal Program designed specifically for the Coco III.**

With advanced features you would expect to find only in a Hi-Priced MS-Dos program. It has a 26 Entry Phone Directory with complete Configuration information for Communications and Automatic logon. Supports the Serial I/O Port up to 2400 baud, Deluxe & Modem Pak and the Disto Serial I/O board up to 9600 baud. It has a Full Screen Text Editor, X/Y Modem File transfer support, Split Screen Conference Mode, Macro Keys. Full Disk Support including Multiple Copy, Kill, Rename, Arc/Un-Arc and Disk Initialize and It is Completely Compatible with ADOS.

Requires 128K, Disk & 80 Col. Display \$44.95

**CoCo III Tool Kit**

**Disk Commands**

Backup, Initialize, Directory, Verify, Compare, Search, Edit, Erase, Speed Test, Stop Rate Test, Gran Tabla Analysis & Repair

**File Commands**

Archive, Copy, Kill, Rename, Erase, View, Edit, Print, Compare, Salvage, Search, Verify, Test Archive, Un-Archive, Ximodem Send/Rec.

**The Disk Utility Program that you always dreamed of is now a Reality.**

Coco Tools is a comprehensive disk utility program providing the most complete set of functions available for the standard R.S. DOS disk system. Comparable in scope and functionality to that of the famous utility available for MS-DOS computers "PC-TOOLS"

Coco Tools is also the most Comprehensive Disk Repair program available. It automatically diagnosis and repairs file allocation errors, locates corrupt directory information and cross linked files. It provides fast and easy recovery of deleted files without the drudgery normally associated with killed file recovery.

Requires 128K, Disk & 80 col. display \$49.95

**This Months Specials**

**Savings Up To 35%**

- EDT/ASM III .....\$49.95
- Window Master.....\$49.95
- Window Master & Window Writer.....\$79.95
- Deluxe Terminal.....\$34.95

**VISA, MASTERCARD or COD**

Call Toll Free 1-800-363-6529

(Monday thru Saturday, 8am to 5pm PST).

To order by mail, send check or money order for the amount of the program plus \$4.00 for shipping to:

**Cer-Comp Ltd.**

**5566 Ricochet Avenue**

**Las Vegas, NV 89110**

**702-452-0632**

Quickie Program

# Bar Graph Printer

**B**ar Graph is a simple 16K Extended BASIC program that is designed to print bar graphs using a Radio Shack dot-matrix printer. You can select the types of data to be entered (the categories) and the data values. The printed result allows you to compare values in related categories and is great for tracking personal budgets.

When run, *Bar Graph* asks you for the title of the graph. The program then prints the title. After this, you are asked to enter a category (rent, groceries, year, etc.) and the value for that category. As written, the program accepts values from 0 to 1000. Enter an E to end the program. *Bar Graph* prints each category and its value as it is entered, so you can print as many different categories as you want in one printout.

The control codes in the program are designed to work with most Radio Shack dot-matrix printers. The

codes and the lines in which they appear are shown in Figure 1. The program does not alter the printer baud location (POKE 150, x) and prints at whatever rate for which the computer is set. (The default power-up rate is 600 baud.)

The printed bars are generated using the STRING\$ function and block-graphics characters illustrated in the Radio Shack printer

Line	Code	Function
100	CHR\$(27);CHR\$(14)	start elongation
110	CHR\$(27);CHR\$(15)	end elongation
110	CHR\$(27);CHR\$(20)	condensed print (17 cpi)

Figure 1: Bar Graph Printer Codes

program to accept values in the 0-10 range, change t000 in lines 30 and 120 to 10. Also change Line 180 to T=N\*t0. To alter the program for a 0-100 range, change 1000 in lines 30 and 120 to t00. Then change Line 180 to T=N.

manuals. The graphics characters used are CHR\$(239) in Line 200, and CHR\$(233) and CHR\$(234) in Line 220.

As stated before, *Bar Graph* accepts data entries from 0 to 1000. To modify the

*Charles Kiedaisch is a retired tool-and-die designer and builder. He still does some design at home, and he uses his CoCo 3 to create master drawings. One of his hobbies is writing programs for the CoCo.*

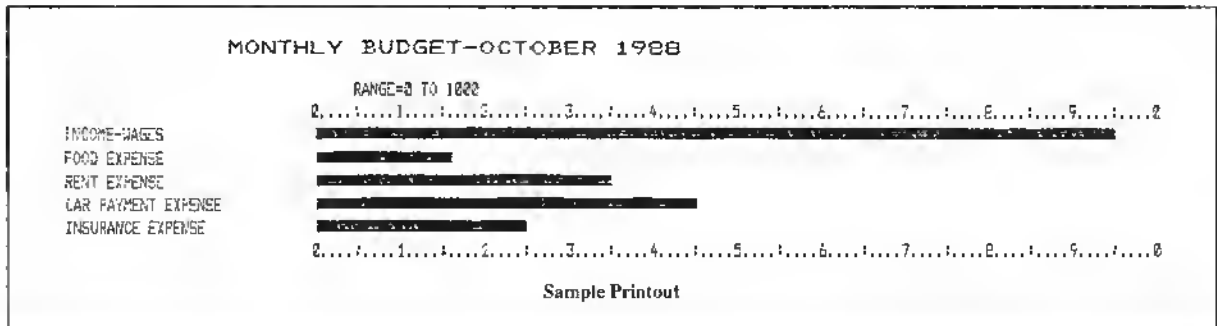

```

16K Extended
The Listing: BARGRAPH
1 'BAR GRAPHER
2 'BY CHARLES A. KIEDAISCH
3 'COPYRIGHT (C) 1992
4 'FALSOFT, INC.
5 'RAINBOW
6 CLS:PRINT"IN THIS PROGRAM YOU
7 WILL BE ASKED TO:"
8 PRINT:PRINT"ENTER A CATEGORY:
9 (E, FOOD, RENT, ETC.)"
10 PRINT:PRINT"ENTER AMOUNT (BETW
11 EEN 0 AND 1000)"
12 PRINT"TO END ENTER <E>"
13 PRINT
14 INPUT"PRESS <ENTER> TO START"
15 ;SS
16 IF SS=CHR$(13)THEN 110
17 CLS:LINEINPUT"NAME/DATE OF GR
18 APH ";D$
19 PRINT@236,"PRINTING"
20 PRINT#-2,TAB(20);CHR$(27);CH
21 R$(14);D$
22 PRINT#-2,CHR$(27);CHR$(15);C
23 HR$(27);CHR$(20)
24 PRINT#-2,TAB(35);"RANGE=0 TO
25 1000"
26 PRINT#-2,TAB(30);"0.....1.....
27 2.....3.....4.....5.....6.....7.....8.....9.....10"
28 PRINT#-2,C$;TAB(30);CHR$(234
29 );STRING$(L,X$);CHR$(233)
30 GOTO 140
31 PRINT@236,"PRINTING"
32 PRINT#-2,TAB(30);"0.....1.....
33 2.....3.....4.....5.....6.....7.....
34 8.....9.....10"
35 PRINT@234,"PROGRAM ENDED"
36 END
    
```

**POKE**

It is easy to tell the CoCo to switch between upper- and lowercase from within a BASIC program. To switch to lowercase characters, use POKE 282,0. (Remember, the CoCo 1 and 2, and the CoCo 3 32-column screen show lowercase as inverted characters.) To tell the computer to return to uppercase, use POKE 282,2. These pokes are real handy for working with the CoCo 3's Hi-Res text screens.

Feature Program

# Expander Gives the Full CoCo 3 Picture

**W**hen adding Super Extended BASIC to the CoCo 3, Microwave chose not to provide support for the full physical capabilities of the hardware. For example, while the CoCo 3 and CM-8 are capable of resolving 225 lines vertically, the built-in software can address only the first 192 lines. *Expander* is a short machine-language program that adds support for the extra lines on the CoCo 3's Hi-Res graphics screens, allowing you to draw bigger images and display more text on the HSCREENS.

Bits 5 and 6 of the video-resolution register (\$FF99) in the GIME chip determine the vertical resolution of HSCREENS 1 through 4. If both bits are clear (zero, or Low), the number of usable lines is 192. (This is the default setting.) However, if both bits are set (one, or High), the CoCo 3 resolves 225 lines vertically. To display

CoCo 3

*Editor's Note: The following listing generates a segmented machine-language program when it is assembled. Since the tape software in the CoCo's ROM cannot handle segmented programs, Expander does not appear on this month's RAINBOW ON TAPE. The program is, however, available on this month's RAINBOW ON DISK.*

The Listing: EXPANDER

```

00100 *****
00110 * HRES GRAPHICS SCREEN EXPANDER *
00120 *
00130 * HSCREEN 3 & 4 HSCREEN 1 & 2 *
00140 * 640 BY 225 320 BY 225 *
00150 *****
00160 ORG $010A
00170 START LDA #934 MHU BLOCK #934 IS NOW USED FOR
    
```

200 lines, Bit 5 should be set and Bit 6 cleared.

*Expander* sets Bits 5 and 6 of \$FF99 and modifies BASIC to support the larger vertical resolution. Since the new screen is 5280 bytes larger, I had to relocate the memory reserved for BASIC's HGET/HPUT buffer space from Memory Block \$34 to Block \$37. The

latter is an 8K block of memory not ordinarily used by BASIC.

The program is written in two sections. The first (lines 160 through 340 in the assembly-language listing) loads into memory starting at Address \$01DA. This is where the cassette I/O buffer usually re-

sides. If you are using a cassette-based system, you'll need to change the address in the first ORG statement to an unused area of memory before assembling the program.

The second half of *Expander* overlays a routine in Super Extended BASIC that is used to switch to the graphics modes. For this reason it must be loaded into memory starting at Address \$E04D. This part of *Expander* also changes the border color to match the background color in all HSCREEN modes.

Once you have assembled *Expander*, put the larger graphics screens into effect by entering LOADM "EXPANDER": EXEC. After the program loads and executes, the OK prompt returns and you can immediately take advantage of the new screen size. All graphics commands work as they did prior to the modification — you do not have to alter existing BASIC programs. Just remember the new limits. For example,

```
HLINE(D,0)-(319,224),PSET,B
```

draws a box around the screen, and

```
MPRINT(D,27),"Message"
```

prints the word Message on Line 27.

*Ron Dahlke is a certified auto technician who has worked in the auto-repair business since 1985. He purchased his Color Computer in 1986 to keep shop records and has been programming since that time. He can be contacted at W7585 Novak Lane, Waterloo, WI 53594, (414) 261-6989. Please include an SASE when requesting a reply.*

### Submitting Material To Rainbow

Contributions to THE RAINBOW are welcome from everyone. We like to run a variety of programs that are useful, helpful and fun for other CoCo owners.

**WHAT TO WRITE:** We are interested in what you want to tell our readers. We accept for consideration anything that is well-written and has a practical application for the Tandy Color Computer. If it interests you, it will probably interest lots of others. However, we vastly prefer articles with accompanying programs that can be entered and run. The more unique the idea, the more the appeal. We have a continuing need for short articles with short listings. These are especially appealing to our many beginners.

**FORMAT:** Program submissions must be on tape or disk, and it is best to make several saves, at least one of them in ASCII format. We're sorry, but we do not have time to key in programs and debug our typing errors. All programs should be supported by some editorial commentary explaining how the program works. We also prefer that editorial copy be included in ASCII format on the tape or disk, using any of the word processors currently available for the Color Computer. Also, please include a double-spaced printout of your editorial material and program listing. Do not send text in all capital letters; use upper- and lowercase.

**COMPENSATION:** We do pay for submissions, based on a number of criteria. This wishing remuneration should *not* state when making submissions.

For the benefit of those wanting more detailed information on making submissions, please send a self-addressed, stamped envelope (SASE) to: Submission Guidelines, THE RAINBOW, The Ealsoft Building, P.O. Box 385, Prospect, KY 40059. We will send you comprehensive guidelines.

Please do not submit material currently submitted to another publication.

```
00180 STA $E0EE EXTENDED HSCREEN MEMORY
00190 LDA #537 MMU BLOCK #537 IS NOW USED AS
00200 STA $E0D4 BASICS HBUFE GET/PUT STORAGE
00210 STA $E3A3 MEMORY
00220 STA $E50B
00230 LDD #5ACA0 NEW MCLS END ADDRESS
00240 STD $E6E7
00250 LDA #225 ALLOW BASIC TO DRAW ON EXTENDED
00260 STA $E7BA PART OF SCREEN
00270 DECA
00280 STA $E7BE
00290 STA $E875
00300 STA $F526
00310 LDA #27 ALLDW HPRINT UP TO LINE 27
00320 STA $EEBF
00330 LOX #5E0E1
00340 JMP $E0F1
00350 *
00360 ORG $E04D NEW MODE SWITCH ROUTINE
00370 PSHS Y,X,A
00380 LBRN $0000
00390 LEAX MDATA,PCR
00400 LEAY MDDOS,PCR
00410 LDA $E6
00420 SUBA #1
00430 LDA A,Y
00440 STA 2,X
00450 LOY #5EEB0
00460 LDA $FE0B
00470 LDA A,Y
00480 STA 3+MDATA,PCR
00490 JMP $E082
00500 MODES EDB $757E
00510 EDB $747D
00520 MDATA FDB $4C80
00530 EDB $0000
00540 EDB $0000
00550 FDB $C000
00560 ECB 0
00570 END START
```

### AWESOME BOOTFILE EDITOR!

# KWIKGEN v1.01

Still using OS9Gen, Cobbler, or Config? Now create boot disks in MUCH less time!

**EzGen v1.09** vs. **KwikGen v1.01**  
5 minutes 40 secs. 44 SECONDS!\*

\*Identical operations on identical fragmented boot disks — 2 deletes and 1 insert performed by both utilities

- Editing done in memory
- Load boot from disk or memory
- Patch modules
- Change order of modules in seconds
- Make multiple boot disks in one session
- Edit existing boot files in place easily
- Load kernel from disk or mem and write to disk

You'll Experience **GALE FORCE Speed!**



Send check or money order to:  
**GALE FORCE ENTERPRISES**

P.O. Box 66036, Sun. F, Vancouver, B.C., Canada V5N 5L4

Checks: allow 4-6 weeks for delivery.  
Money orders: processed immediately for KWIK delivery  
604-522-6922



Introductory price:  
**\$19.95 U.S.**  
(+\$4.00 shipping and handling)

# BRAND NEW!!!

Introducing A Brand New Product For The COCO 3:

## COCO FRIENDS DISK MAGAZINE



It's part magazine, part BBS and part shareware! COCO FRIENDS DISK MAGAZINE is dedicated exclusively to those who still enjoy running their COCOs under RS DOS! This new product will rekindle the fire in your COCO computing life. Articles, programs, opinions, reviews, and more presented in a more personal way than you have ever experienced before!

Come and join you COCO friends! Get better acquainted. Share your views and reviews. See never before seen programs, graphics, and more! You and your COCO deserve it! We'll see that you get it!

If this sounds good to you, I invite you to investigate now. Dive in and get ready to have FUN!! Send \$6.00 (check, cash or money order) now. You'll receive the COCO FRIENDS DISK MAGAZINE STARTUP KIT. Browse this shell and give us your input with the built-in ENTRY WRITER. Make any other contribution in the nature of your original work. Send a copy back to RICK'S COMPUTER ENTERPRISE and we'll send you the next issue. (The startup kit and the first issue cost only \$6.00)

If you like what you see, become a regular subscriber at the low cost of \$30 for 6 issues. If it's not for you...well that's okay, too. There's no further obligation. I think you'll agree, this is an offer you can't refuse!!

Don't put it off. Get in on the ground floor and help keep the COCO community strong!! We'll be expecting to hear from you soon!

SEND CASH, CHECK OR MONEY ORDER TO:

## RICK'S COMPUTER ENTERPRISE

TEL: 606-787-5783  
CODs Add \$2.50  
P.O. BOX 276  
LIBERTY, KY. 42539

CoCo Consultations continued from Page 4

fact that I had a mouse on COM 1 and was trying to do serial communications via the mill-modem cable on COM 3. I just got around to trying this theory by unplugging the mouse and using the mill-modem cable on COM 1. It now works perfectly.

Tril Jurger (TEDJAEGER)  
Fulani, Montana

**A** Great! Now try putting the mouse on either COM 2 or COM 4 while using either COM 1 or COM 3 for serial communications with the terminal program. I suspect you will find things will work fine.

#### Connecting Epson Printers

**Q** I recently acquired an Epson LX-800 printer that I want to use with my Color Computer 2. How do I connect the printer to the computer?

Robert Russel  
Sorrano, Florida

**A** All Epson printers I have seen come with a parallel interface. You will need to use a serial/parallel converter to connect the CoCo 2's serial port to the parallel port on the Epson. Epson makes serial/parallel converters that plug inside many of its printers. With such a unit installed, you'd just need a CoCo printer cable (4-pin DIN to DB-25 with pins 4, 3 and 2 of the CoCo

DIN going to pins 3, 7 and 20, respectively, of the DB-25 connector).

I'm not specifically familiar with the LX-800 printer. Some Epson printers have, in addition to a 36-pin Centronics parallel connector, a 6-pin DIN serial connector. If your printer has such a serial port, you may be able to use the printer with your CoCo after making up a proper cable. You'll have to check the manual to get the pinout for that port in order to make a cable to connect it to the CoCo. (You'll also need to check the manual for the correct DIP switch settings for the printer to use the serial port.) Connect Pin 4 of the CoCo DIN to the "data in to printer" pin on the Epson. Connect Pin 3 of the CoCo DIN to the Ground pin on the Epson serial connector. Finally, connect Pin 2 of the CoCo DIN to the "busy handshake line" of the Epson. Note that the CoCo requires that the Bnsy signal be low when the printer is busy.

#### Modem Won't Talk Back

**Q** I recently got a new 2400-bps Hayes-compatible modem, and it displays an odd idiosyncrasy when hooked to my Tandy RS-232 Pak. I can tell it to dial, and it dials, and it answers properly and works fine once connected. However, while it is in its normal state, I cannot see anything onscreen the modem is sending to my computer. That is, if I type AT, I do not see OK. If I type ATDT ####-####, the modem

dials the specified number, and once connected the modem works fine. But I see neither ATDT ####-#### nor any connect messages. Note that I have set the modem to ATE1 (turning on the echo), but to no avail. I use a straight-through cable between the modem and the RS-232 Pak for pins 2, 3, 4, 5, 7, 8 and 20, although I also route Pin 8 of the modem to Pin 6 of the RS-232 Pak to enable my BBS to properly detect carrier.

Lavern Schoonover (LVSCHOONOVER)  
Idaho Falls, Idaho

**A** Your problem is that the 6551 ACIA chip in the RS-232 Pak will not receive any data unless it has a valid signal on its carrier-detect line. There are generally two possible solutions to this problem.

One solution is to make a cable that is like your current cable, except that it does not route Pin 8 of the modem to Pin 8 of the RS-232 Pak. Keep Pin 8 of the modem going to Pin 6 of the RS-232 Pak for the benefit of your BBS program, but also short Pin 8 and Pin 20 of the RS-232 Pak together. This will force Pin 8 of the RS-232 Pak high whenever Pin 20 of the RS-232 Pak is high. Since all terminal programs make Pin 20 (DTR) of the RS-232 Pak high when they are activated, you should now be able to see responses sent by the modem on your screen, even when the modem is in command state.

Alternatively, if you are using a straight-

through cable, send the command AT&C0&W to the modem. This first activates the &C0 option, where the modem makes its carrier-detect line high regardless of whether it has detected a carrier or not. The &W command writes this in the non-volatile RAM in the modem, so that it defaults at power on to that state of carrier detect forced high all the time. To return the modem to normal function with respect to its carrier-detect pin, type AT&C1&W. This is assuming, of course, your modem supports both the &C and &W commands that are part of the Hayes Smart-modem 2400 command set.

I recommend the hardware fix, for it is compatible with the special modification you have made for your bulletin board, whereas the software fix removes the ability to use hardware to determine whether the carrier is or is not active. But for those using the modem with terminal programs (those not running BBS programs on their CoCo), the software fix is by far the quickest, simplest and most effective approach.

Martin H. Goodman, M.D., a physician trained in uroesthesiology, is a longtime electronics tinkerer and outspoken commentator — sort of the Howard Call of the CoCo world. On Daphni, Murry is the SIGOP of THE RAINBOW'S CoCo SIG. His non-computer passions include painting, mountaineering and outdoor photography. Murry lives in San Pablo, California.

#### Product Review

### Rick's Treasure Chest: Unbelievable Offer #3

Rick's Computer Enterprise has done it again by bundling a wide variety of quality programs at an extremely low price. Shrewd investment opportunities are always welcome in these hard economic times, and it's even better when they are of immediate benefit to your children. This package is a good learning tool for elementary or junior high school students.

*Unbelievable Offer #3* includes several educational programs. *Cirmath* helps children with simple addition problems. The student's score is based not only on correct answers but on reaction time. Another program, *Micro*, displays a microscope with its different parts labeled for review. After the student has memorized the parts, he takes a short quiz to test memory skills. *Spelling* is an eleven-word spelling tutor. The tutor flashes a word onscreen (at one of four speed settings) and prompts the user to re-type the word. Instructions are given for changing the words. Both *Micro* and *Spelling* display the percentage of correct answers.

Remember learning the states and capitals in geography class. (Is geography still taught in our elementary schools?) To help students learn geography, *Unbelievable Offer #3* includes some fine programs that cover this topic: *US Drill* and *Locate*. *US Drill* tests the student's ability to identify and locate states and capitals. *Locate* features drills for latitude, longitude, major cities of the world, the continents, countries

of the world and famous landforms. A tutorial is provided for brushing up on longitude and latitude skills.

How much does your child know about U.S. presidents? *Presidents* is designed to test knowledge of presidents in two ways. In the first approach, the program asks up to three general questions regarding a specific president. The second approach involves questions of a which-president-came-first nature.

After a hard day at school, what better way is there to unwind than to play some games. *Unbelievable Offer #3* includes nine games that should appeal to children of all ages. *Tictac* is a math version of tictac-toe. This game requires players to correctly answer a two-digit addition or subtraction

problem before placing an X or O on the game board. Also included are a version of *Hangman* and a *Simon*-type simulation called *Simon*, which tests memorization skills. (Yes, I know these are educational programs, but they're games, too!)

Remember being given a slide puzzle of the United States to keep me amused on long car trips. (My brother would craftily mix the tiles, sometimes leaving an east-

coast state way over on the west coast.) *Pluside* is a picture-slide puzzle that loads a NIB-format picture and scrambles it into 15 pieces — you've got to unscramble 14 of them. When (and if) you manage to do so, the computer places the final piece in the puzzle. *Minuside* is a number-slide puzzle in which you must rearrange 31 tiles in ascending order.

Perhaps the toughest game of the bunch is *Wheels*. The goal is to split seven connecting wheels, aligning the colors inside each wheel with matching colors on adjacent wheels.

Give *Connect* a try if you like word-association games. You are shown a word underneath which are the first letters of six other words; the goal is to figure out the six other words by word-association. Also in the word-game genre is *Discover*, a *Scrabble*-type game. The twist is that you must uncover words already hidden on the game board. Your turn lasts until you've uncovered a word or hit a blank spot on the board. You receive points for finding words — the player with the highest score wins. The last game included with *Unbelievable Offer #3* is called *Takesome* and is played against the computer. A random number of apples is placed on the screen. You can remove up to three apples per turn. The player left with the last apple loses.

Disk 2 of *Rick's Treasure Chest* contains three utilities and one home-help program. *Colprint* is a color-print driver for users of the Star NX-1000 color printer. This machine-language program automatically selects the palettes for printing color pictures. *Palsover* is designed for use with *VMaster*, a popular public-domain graphics viewer. Normally, if the Reset button is pressed while running *VMaster*, the cor-

rect palette data is lost. *Palsover* saves the correct palette data, allowing you to use the graphics — with correct colors — with other programs.

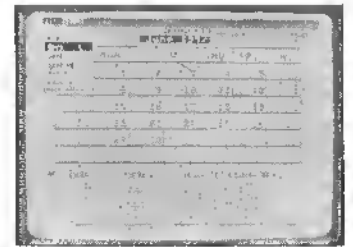

Many people who have a CoCo 1 or 2 also have a collection of PMODE graphics images. If you've upgraded to a CoCo 3, you can use *Transpic* to quickly and easily transfer PMODE images for display on MScreens.

Most everyone who shops at a grocery store knows the importance of having a list of items to buy. *Shopper* is a database that takes the grocery selection process one step further. Not only does it allow for printing grocery lists, it stores information for price comparisons for up to four different stores. *Shopper* works best when used with an RGB monitor.

Though system requirements aren't listed in the manual that comes with *Unbelievable Offer #3*, an advertisement in THE RAINBOW did state that a CoCo 3 and an RGB monitor are required. However, I found using a monochrome monitor or T.V. to be adequate with most of the programs.

This bundle of 20 software programs is quite a steal. Considering the time and effort required to create these programs, and the price of \$20 (one dollar per program) you're getting a lot of bang for your buck. Frugal shoppers should seriously consider buying this package. It really is an unbelievable offer. (Rick's Computer Enterprise, P.O. Box 276, Liberty, KY 42539, 606-787-5783; \$20.)

— Jamie Heisen

Telecommunications

# Serial Asynchronous Communication

This article describes concepts and applications for serial asynchronous communication. Most of the definitions and communications topics discussed here are generic and apply to any computer system, large or small. Introduced are basic data communications concepts and EIA-232-D (RS-232-C) issues.

## Applications for Serial Communication

Perhaps it would be best to start by describing why anyone would want a communications interface. Communications interfaces allow data transfer between a computer and such external devices as another computer, a modem, a printer, a terminal, home security equipment, laboratory apparatus or robotics devices.

Many types of communications interfaces are available for computers: serial or parallel, synchronous or asynchronous, full-duplex or half-duplex. These terms will be defined later; let it suffice for now that serial asynchronous interfaces are the least expensive and simplest available.

My personal application was to build a small, simple network for file transfers between several small computers in my office. The computers I needed to connect were an Apple II+, a TRS-80 Model 100 portable computer and a Tandy 1000. Serial interface boards I purchased for the Tandy 1000 and the Apple, plus the built-in serial port on the Model 100, let me easily exchange text files between any pair of ma-

chines. The key is that all the serial ports use the Electronics Industries Association (EIA) RS-232-C standard hardware interface.

Serial interface hardware usually does not come with software to control it. Furthermore, RS-232-C (or EIA-232-D, as it is now known) specifies only the electrical interface and is therefore independent of the controlling software. This standard hardware interface allows any appropriate software to work together. In my case the Tandy 1000 serial port is controlled using either the Telecom software that is part of *DeskMate* or the *Crosstalk XVI* communications package. The Model 100 is controlled by its built-in Telecom program; the Apple, by software I wrote. The point is, I have never had any problem exchanging files using these different pieces of software.

## Introducing Data Communications

To really understand what is meant by serial asynchronous communications, it is necessary to present some basic data communications terms and concepts. I recommend two books for any reader who wants to really delve into this topic. *Technical Aspects of Data Communication*, by John E. McNamara, is one of the best books

available on the technical nitty-gritty of communications hardware and interfaces. *Data and Computer Communications*, by William Stallings, is a good overview of

## Serial vs. Parallel Communication

Let's start by differentiating between serial and parallel communication (Figure 1). In a parallel system all bits of a word (or character or byte) are transmitted at one time, each bit on a separate wire or circuit. An additional wire is required to carry a clock signal, necessary to keep the transmitter and receiver in synchronization with each other. In a serial system there is only one wire for bit transmission, where each bit in the word is sent one after the other. Assume that we have an eight-bit byte.

A parallel system, then, requires at least nine wires for the clock and data; only one bit time, however, is required to transmit the entire byte. Conversely, a serial system requires only a single transmit circuit and eight bit times to transmit a byte.

(As an aside, the term *byte* usually means a character but does not always refer to an eight-bit quantity. The standard term *octet* is used to unambiguously refer to an eight-bit entity. In this article I use byte as a synonym for octet.)

Figure 1 shows the American Standard Code for Information Interchange (ASCII) representation of the character E as 01000101 (Hex 45).

Note that the leftmost bit is called the Most Significant Bit (MSB) and the rightmost bit is the Least Significant Bit (LSB). Most serial systems transmit the LSB first.

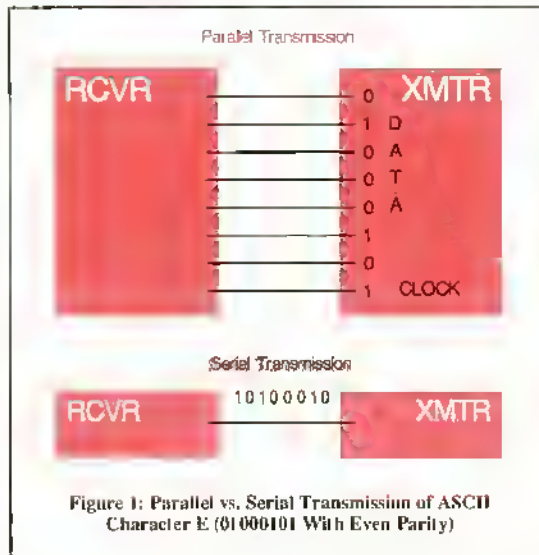

Figure 1: Parallel vs. Serial Transmission of ASCII Character E (01000101 With Even Parity)

# stair Plug 'n' Go for Your CoCo!



**7 Color Printer!**

## stair NX-1020

This CoCo compatible NX-1020 system sets new standards in color printer performance... 225 cps, 4 NLD fonts including Script, plus a high speed draft font; but the enhancements don't stop there. Add a 16k buffer, a special gsm mode, top lead, bottom and rear tractor, and the list goes on. Seven on-demand colors, 8 color graphic modes, Epson and IBM emulation for maximum software compatibility. Virtually everything desired in a printer is here — speed, color and versatility at an affordable price with a 2 year warranty.

**Our Plug'n'Go for the CoCo system includes:**

- NX-1020 Multi Font Color Printer
- Blue Streak Ultima
- Software Support Disk
- Color Graphics Utilities

\$239<sup>95</sup>

\* \$10 Shipping & Insurance



## stair NX-1001

This CoCo compatible NX-1001 system is fully featured with 4 NLD plus a draft font, 10 character sizes from subscript to quadruple size, 4k buffer, 180 cps, tractor and tractor lead, and much much more. Backed by a 2 Year warranty, Epson and IBM emulation modes for maximum software compatibility. A performer so versatile you may never exhaust it's creative possibilities!

**Our Plug'n'Go for the CoCo system includes:**

- NX-1001 Multi Font Printer
- Blue Streak Ultima
- Software Support Disk

\$188<sup>88</sup>

\* \$10 Shipping & Insurance



## The Ultimate Serial to Parallel Interface!

### The Blue Streak Ultima

**7 Switchable Baud Rates - 300 thru 19200!**

- An interface cable that converts the serial output of a CoCo 1, 2 or 3 to a standard parallel format, compatible with modern parallel printers.
- Connecting the Ultima is as easy as plugging in the cable! The four pin pin plugs into the serial I/O port of your CoCo and the other end, a 36 pin connector, connects to the parallel port of the printer.
- The Ultima is powered with the +5V supplied by most printers on pin 18. If your printer does not have +5V on pin 18 you'll need to add the power option when ordering.

\$39<sup>95</sup>

\* \$2 Shipping  
POWERED VERSION  
ADD \$6.00

**STAR 24 WIRE PRINTER SYSTEMS ALSO AVAILABLE!**  
CoCo compatible • Color and Monochrome • Call for pricing

## Order Your System Today... Call (513) 885-5999

**DAYTON ASSOCIATES, INC.**  
9644 Quailwood Trail • Spring Valley, Ohio 45370

Visa & Mastercard Accepted

Ohio residents add 6.5% sales tax. C/D add \$4.00  
Shipping charges in Canada, P.R., HI, AK, and U.P. are double. 1 rate charge to all other countries.  
Price and Spec. I allow for subject to change without notice.

All Dayton Associate's products have a 30 day moneyback guarantee.

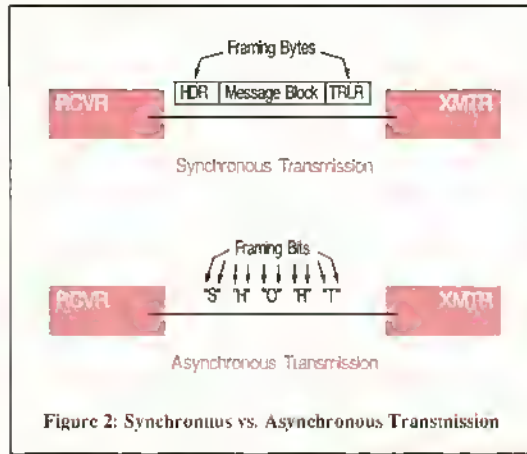

Figure 2: Synchronous vs. Asynchronous Transmission

Parallel communication interfaces are common in internal computer buses, such as those between the processor and a disk drive or between the chips on the motherboard. Computer buses are typically relatively short (less than a hundred feet or so), operate at high speed (several megabytes per second), and are vendor-specific. That is, if a third party wants to develop a device to plug into the Color Computer cartridge port, for example, the device must conform to a hardware specification written by Tandy for the CoCo.

Most computer owners are familiar with one commonly used parallel interface: the Centronics interface. The Centronics bus is usually used for computer-to-printer applications and has a limited distance: it is not designed for general computer-to-computer communication.

Communications between computers may be over long distances (upwards of thousands of miles), operate at relatively low speeds (usually limited to 19,200 bits per second over the dial-up telephone network), are typically serial, and usually use a vendor-independent interface. The goal is for machines built by different vendors to communicate easily with each other.

It is beyond the scope of this article to explain all the reasons computer-to-computer communication is usually serial. Consider, however, that parallel communication requires many more wires than does serial. The number of wires usually equals the word size; how, then, should machines with unequal word size communicate? What happens when I upgrade my eight-bit computer to a 16- or 32-bit computer? Indeed, cost is a major reason serial communication is preferred.

Consider also that a large amount of computer-to-computer communication uses the telephone network. On the order of one billion miles of wire is already in place in this country's telephone network; a single wire easily supports serial communication but cannot support parallel.

Finally, parallel communication systems require clocks and repeaters to ensure that all bits in a word stay in synchronization with each other. This adds to the cost of those systems.

McNamara's and Stallings' books provide more motivation on the serial/parallel issue; we will continue our discussion with serial communications only.

**Synchronous vs. Asynchronous**

Serial communication can be either *synchronous* or *asynchronous*. These terms refer to the timing relationship of characters in a message with respect to each other.

Serial transmission must have framing information immediately before and after the actual data bits to be transmitted. Fram-

ing information is used by the transmitter to let the receiver know that something important is about to happen — namely, that user data is coming down the line. Framing information at the end of transmission indicates that the data block is completed.

In asynchronous communication (Figure 2), all bytes in a message are transmit-

**Types of Transmission Channels**

Finally we must distinguish among the different types of transmission channels. Channels can be simplex, half-duplex, or full-duplex.

A *simplex* link is one where information flow can be in only one direction. An example is the link between a stereo and its speakers, or the transmission from a TV or radio station. Simplex links are not of common interest for data communications.

Most useful data-communications applications require channels in which data can flow in both directions. In the *half-duplex* environment, information can flow in both directions but in only one direction at a time. An example is the communication between two people; the air carries words in both directions, but rules of reasonable conversation dictate that both people don't speak at the same time. The operation of CB and most other two-way radios is another example of half-duplex communication.

It should be clear that some rules are necessary to indicate which end of the link should transmit next in these systems. A *full-duplex* channel is one in which information can flow in both directions simultaneously. Computer-to-computer communication is typically full-duplex. Full-duplex is frequently referred to simply as duplex.

This article is oriented toward serial, full-duplex, asynchronous communication. This type of communication is very general and relatively simple, not requiring a complex protocol.

**Asynchronous Transmission**

Figure 3 shows the format of an asynchronous character. During periods of no transmission, power is applied to the line to keep it in the ON state. Since a line that is cut will have no power on it, a bad line and an idle one are easily differentiated.

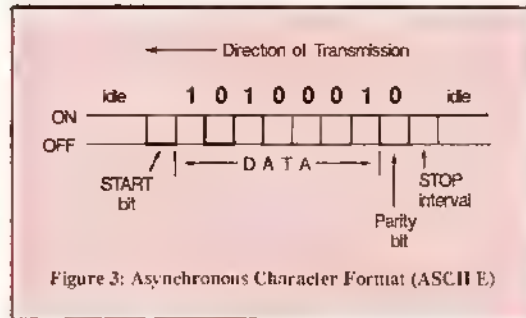

Figure 3: Asynchronous Character Format (ASCII E)

ted together as a block, one byte immediately after the other. The data message block is preceded by a header (HDR) and followed by a trailer (TRLR); these are the *framing characters*. In synchronous-communication protocols, framing characters can include such information as a message sequence number, message type, acknowledgement of a previous message, and error detection information. Usually the number of framing characters is very low compared to the amount of data. For example, the Digital Equipment Corporation DECnet protocol allows messages of up to 16,383 octets in length; the additional framing information is only 10 characters in length.

Asynchronous communication systems (Figure 2) transmit every character (or word) in a message individually, without regard to when previous characters were transmitted. Each character has at least two framing bits. A START bit precedes a character, letting the receiver know that data bits are about to come in. Then the bits comprising a single character are received. The transmission is terminated with a STOP period.

Asynchronous communication is typically used between a terminal and a computer. This is because users of terminals tend to be relatively slow compared to the computer. The human user is part of the error detection and correction cycle. Typographical errors, when seen, can be easily corrected with the Backspace key. Erroneous messages are typically indicated with a Syntax Error message and corrected when the user retypes the message correctly.

Computer-to-computer communication, on the other hand, is usually at high speeds and tends to be synchronous. A communications protocol must be used for error detection and correction, since a user cannot monitor the high-speed communication and certainly could not make necessary corrections.

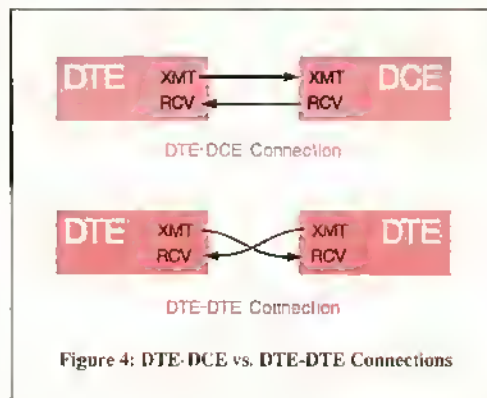

Figure 4: DTE-DCE vs. DTE-DTE Connections

When a character is sent, the receiver detects a transition from the ON (or MARK) state to the OFF (or SPACE) state. This OFF state lasts for a single bit time and is called the START bit. The appropriate number of data bits are then received, where the LSB is usually received first. The data bits are followed by a STOP interval, during which time the line is held in the idle (ON) state for 1, 1.5, or 2 bit times. The use of the STOP interval is based on printing terminals, which require a reset period between each character received.

The *band* indicates how many signals per second are sent down the wire; *band* means *signals per second*. The *bit rate* refers to how many bits are sent down the wire per unit time and is typically denoted *bits per second* (bps). The bit rate may be different from the baud, depending upon how many bits are sent with each signal; only if one bit of data is sent with each signal are the band and bit rate the same.

An example helps clarify these concepts. If a signal lasts for 0.00333333 seconds (or 3.3333 milliseconds), the device is operating at 300 baud (one signal per 0.003333 seconds equals 300 signals/second). If each signal carries a single bit, the bit rate is 300 bps; if each signal carries four bits, the bit rate is 1200 bps.

The difference between bit rate and baud is very important. It can be easily shown that transmission over ordinary telephone lines cannot exceed 6000 baud or so. However, the bit rate can be on the order of 30,000 bits per second. These numbers are based on Nyquist's and Shannon's theorems, well beyond the scope of this article; interested readers are referred again to McNamara or Stallings.

*Parity* is an error-detection mechanism. In an even-parity system, all characters must have an even number of one bits turned ON; in an odd parity system, an odd number of one bits must be ON. Consider the seven-bit ASCII characters A (100001) and E (1000101). When parity is used, these seven-bit characters are transmitted as eight-bit entities where the MSB, or leftmost bit, is the parity bit.

In an even-parity system, A, with an even number of one bits already ON, has the parity bit turned OFF; thus it is sent as 01000001. The E, on the other hand, has an odd number of one bits, so its parity bit is ON to make the number of one bits even; thus E is sent as 11000101. In an odd-parity system, characters A and E are represented as 11000001 and 01000101 respectively (see Figure 3).

Two other types of parity systems can also be used. In a MARK-parity scheme, the parity bit is always set to 1. In a SPACE-parity scheme, the parity bit is always zero.

**The EIA-232-D (RS-232-C) Interface**

The RS-232 standard is the most commonly used interface in the United States for serial, asynchronous communication between terminals, computers, and modems operating at speeds below 20,000 bps. (The International Telegraph and Telephone Consultative Committee (CCITT) Recommendation V.24, essentially identical to EIA-232-D, is commonly used outside North America.) The EIA first released Recommendation Standard 232 (RS-232) in 1961. In 1969 RS-232-C was made available. RS-232-C remained virtually unchanged until 1988, when EIA-232-D was adopted. Since EIA-232-D is basically the same as RS-232-C, this article treats them as if they were the same (except where noted). The EIA was renamed the Telecommunications Industry Association (TIA) in 1989.

EIA-232-D can be used in either the synchronous or asynchronous transmission environment. The standard defines the electrical characteristics of the interface and the circuits that must be present to effect communications. Pin numberings are provided for the typical D-shaped, 25-pin connector (DB-25) most often associated with RS-232-C. Although RS-232-C did not specify that the DB-25 connector be

used, the EIA-232-D version does. (This means you can purchase an "RS-232-C" device that uses a connector other than the DB-25.)

It is often said that RS-232-C/EIA-232-D limits devices to a maximum separation of 50 feet; this is in fact not the case. One electrical characteristic defined in the standard is the maximum allowable capacitance, which is limited to 2500 picoFarads (pF). Since normal cable has a capacitance of 50 pF/foot, a limitation is usually quanted. Significantly longer separations are possible using low-capacitance (or *low-cap*) cable.

A detailed description of the EIA-232-D standard, circuits, and their operation is also beyond the scope of this article, but Kessler and McNamara describe it in detail. A copy of the standard may also be obtained from the EIA (or TIA) at 2001 Eye St. NW, Washington, D.C. 20006. Finally, the book *RS-232 Made Easy*, by Martin Seyer, is full of excellent information for either the professional or hobbyist wanting to interconnect RS-232 devices or gain a better understanding of the standard.

**EIA-232 Cabling**

Many people build their own EIA-232 cables because they are expensive to buy but easy, cheap and fun to build. Two male (or female) solderless connectors and a 25-lead ribbon cable cost about \$15 and yield a fine 25-foot EIA-232 cable. These items are available from most Radio Shack or electronics supply stores. A caveat, however, must be provided regarding this practice.

Most people who build their own cables connect all 25 leads of the ribbon cable to the connectors. However, some of the pins are unassigned by the RS-232-C and EIA-232-D specifications, and most of the other

leads are unused for most common applications; in fact 10 or fewer of the pins are used for most applications. For this reason some manufacturers put test points at these "unused" pin positions. Using a cable with

the transmit (XMT) lead and receives from the DCE on the receive (RCV) lead. In other words, DCE devices receive data on the XMT line and transmit on the RCV line. However, DTE devices transmit on the

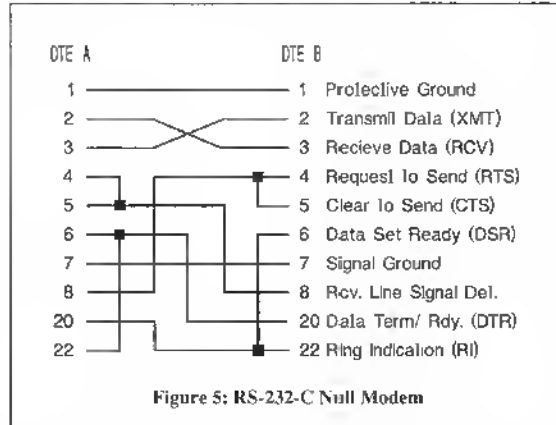

Figure 5: RS-232-C Null Modem

all 25 conductors connected could allow too much voltage to enter a device if you do not know exactly how a "foreign" device is internally wired. The way around this is to pull out the pins of all unused leads from at least one of the connectors (and preferably from both).

Another cabling issue regards a null-modem cable (Figure 4). EIA-232 recognizes two types of devices, *Data Terminal Equipment* (DTE) and *Data Communications* (or *Circuit-terminating Equipment*) (DCE). EIA-232 expects that a DTE be connected to a DCE; e.g., a terminal or PC (DTE) connected to a modem (DCE). If a DTE and DCE are connected with a normal EIA-232 cable, the communication works fine since the DTE transmits to the DCE on

the transmit (XMT) lead and receives from the DCE on the receive (RCV) lead. In other words, DCE devices receive data on the XMT line and transmit on the RCV line. However, DTE devices transmit on the XMT line and receive on the RCV line.

If two devices set up as DTEs (e.g., two PCs) are connected, the two XMT circuits are connected to each other, as are the two RCV circuits. Obviously these two devices cannot communicate. The null-modem cable crisscrosses the XMT and RCV wires so that the transmit pin at one end is connected to the receive pin on the other end and vice versa. This is a common application; if two computers are in the same room, do you want to connect them using two modems and two phone lines or using a single short cable? Additional leads must also be crossed by the null-modem cable to allow the devices to communicate. A null-modem box allowing the direct interconnection of two DTEs can easily be built with the wiring diagram shown in Figure 5. Note that only 10 leads are shown in the diagram. This is a specified EIA-232 subset providing support for asynchronous, leased-line — dedicated — applications.

A way around using a null-modem cable exists in some applications. Some EIA-232 products allow the user to configure the device as either DTE or DCE. If one device is configured as a DTE and the other as a DCE, a null-modem cable is not needed. Before building or buying a null modem, check the specifications of the devices you are trying to connect.

**Summary**

A great many topics have been declared "beyond the scope of this article." Parallel communications, synchronous communications protocols, EIA-232-D details, other interface standards besides EIA-232, information theory, error-detection techniques, and computer networks are among the many topics that can be greatly expanded upon. It is to be hoped this introduction encourages the reader to pursue more in the data communications area.

**References**

- Kessler, G.C., "Unraveling RS-232," (LAN, August 1988)
- McNamara, J.E., *Technical Aspects of Data Communication*, Third Edition (Maynard, Mass.: Digital Press, 1988)
- Stallings, W., *Data and Computer Communications*, Second Edition (New York: Macmillan, 1988)
- Seyer, M.D., *RS-232 Made Easy* (Englewood Cliffs, N.J.: Prentice-Hall, 1984)

Gary Kessler is a data communications and computer networking consultant. He may be contacted at 5 Creek Glen, Colchester, VT 05446-3641, (802) 879-3375; or via electronic mail to KUMQUA T@SMCVAX.BITNET.

**EDUCATIONAL PROGRAMS FOR THE TANDY (RADIO SHACK) COLOR COMPUTER 2 & 3 32K DISK OR CASSETTE**

**A BIBLE ADVENTURE!**

An exciting, non-graphic 32K adventure based on the Bible.

**BIBLE SCRIPTURES**

Quizzes on important Bible Scriptures.

**ALSO**, other quizzes on the Bible, **PLUS** programs on Vocabulary, Word Usage, Spelling, and Math.

**Instructional, Informative, Neat, Colorful, With Block Graphics and Pleasing Sound**  
**Bible Programs \$12.00 - Instructional Programs \$10.00**  
**Both sets for \$19.00**

Complete instructions and information included!

To Order, send check or money order to:

Sebastian LaSpada  
 531 Main Street  
 Dunkirk, New York 14048

For Information, Call (716) 366-5261

**Educational Fun for the Entire Family!**



**40 NEW GRAPHIC DISKS!**

Our three graphic sets (10 disks each set) were so popular, we've added 4 more!



Every order includes Macpaint - an excellent graphics editor. Graphic pictures are Coco Max compatible.

Prices: \$20 per 10 disk set 3 or more sets - \$15 each  
 Special: All 7 sets - \$90

Set #1 Clipart Animals More	Set #2 Celebrities Cartoons More	Set #3 R-Rated Women Adults Only	New Sets 4,5,6,7 Each set has a variety of: Business Clipart, Grim Graphics, Sports, Special Events Plus much more!
--------------------------------------	---	---	---

Mail To: Name \_\_\_\_\_  
 Address \_\_\_\_\_  
 City \_\_\_\_\_ State \_\_\_\_\_ Zip \_\_\_\_\_  
 T&D Subscription Software  
 2490 Miles Slandish Drive  
 Holland MI 49424  
 (616) 399-9648  
 Fax: (616) 396-2744  
 Credit Card # \_\_\_\_\_  
 Expiration \_\_\_\_\_ Total \$ \_\_\_\_\_  
 Please Circle Graphic Disk Sets 1 2 3 4 5 6 7

**Purchase Orders** continued from Page 1

gram provides the dollars-and-cents format for you. After you complete the entries for your order, you can enter appropriate shipping charges. You also have the option of adding sales tax if necessary. (I'll show you how to modify the rate shortly.) The final prompt on this screen provides you with the opportunity to include a note. I find this useful for mentioning THE RAINBOW ad to which I am responding and for specifying details about my system to ensure receiving the right product.

Once you've finished with the main data-entry screen, the program automatically takes you to the method-of-payment screen. CoCoPO supports three methods of payment: check, VISA or MasterCard. Simply press the first letter of the appropriate method. (For other methods, see the section covering Personalizing below.) At this point, CoCoPO gives you the option of saving the data to disk and returns you to the Main menu.

From CoCoPO's Main menu you can display the information to make sure it is correct, or you can print the information by choosing the hardcopy option. (CoCoPO is set up for a Radio Shack printer, though with very minimal modifications, the program should work with any printer.) The display screen contains all the pertinent information about your order. In the upper-left corner of the screen you will see a single letter corresponding to the chosen method of payment (C for check, M for MasterCard and V for VISA). This is to get around the 24-line limitation of the screen without having to add another screen in the pro-

gram. It also serves as a reminder about which method of payment you selected for your order.

**Personalizing CoCoPO**

Variable L in Line 900 affects the sales-tax rate. I used .07 (7 percent) since that represents the state sales tax here in New York. If your state tax is different, substitute the appropriate value in that line.

As stated before, CoCoPO supports three methods of payment. The subroutine between lines 2640 and 2720 allows the user to enter a single letter corresponding to the method of payment. Lines 1980 through 2020 contain the conditional statements that affect the hardcopy. Lines 2740 through 2840 are the lines you must modify in order to get the proper output. If you use MasterCard and/or VISA, replace the X's with your card numbers and expiration dates. If you do not use credit cards, simply delete the lines containing this information.

The other areas of CoCoPO that need to be personalized are lines 2060 through 2120. Edit these lines to present your address and phone number.

I enjoyed writing CoCoPO. If you have any comments, suggestions or problems, please feel free to contact me. Happy CoCo computing!

*Roger F. Krueger is a self-taught BASIC programmer who started using the Color Computer in 1981. He may be contacted at 224 Main Street, Dansville, NY 14437. Please include an SASE when requesting a reply.*

```

0 ELSE 1020
1000 LOCATE 0,23:LINEINPUT"Note "
;PS$
1020 GOSUB2640
1040 CLS
1060 LOCATE15,12:LINEINPUT" +
+ + Save to Disk (Y/N)? + +
";SOS
1080 IF SD$="Y" OR SD$="y" THEN
1100 ELSE RETURN
1100 LOCATE 15,14:LINEINPUT"File
name: ";F1$
1120 OPEN "0",#1,F1$
1140 FOR X=0 TO VAL(Z$)-1
1160 WRITE#1,PP$,T,L,0$,A1$,A2$,
A3$,Z$,A$(X1,B$(X1,C$(X1),SH$,PS$
),PY$
1180 NEXT X
1200 CLOSE:RETURN
1220 CLS
1240 SOUND 200,1:LOCATE 20,5:LIN
EINPUT"Filename: ";F1$
1260 OPEN "1",#1,F1$
1280 X=0
1300 IF EOF(1)=-1 GOTO 1380
1320 INPUT#1,PP$,T,L,0$,A1$,A2$,
A3$,Z$,A$(X1,B$(X1),C$(X1),SH$,PS$
),PY$
1340 X=X+1
1360 GOTO 1300
1380 CLOSE:GOTO 2200
1400 CLS:T=0
1420 ATTR 5,1,8
1440 LOCATE 18,11:PRINT"Printng
, please wait . . ."
1460 ATTR 5,1
1480 PRINT#-2,TAB(51)"Purchase Or
der #":PP$
1500 PRINT#-2:PRINT#-2
1520 PRINT#-2,TAB(50)ID$
1540 PRINT#-2,TAB(5)A1$
1560 PRINT#-2,TAB(5)A2$
1580 PRINT#-2,TAB(5)A3$
1600 FOR X=1 TO 3:PRINT#-2:NEXT:
PRINT#-2,TAB(51)"Dear Sirs:":FOR
X=1 TO 2:PRINT#-2:NEXT
1620 PRINT#-2,TAB(51)"Please ship
the items listed as soon as pos
sible."
1640 PRINT#-2
1660 GOSUB 3040
1680 PRINT#-2,TAB(51)CHR$(151):PR
INT#-2,USINGF$;L1$,L2$,L3$,L4$
1700 PRINT#-2,CHR$(114)
1720 FOR X=0 TO VAL(Z$)-1
1740 PRINT#-2,USINGF2$;VAL(A$(X1)
),B$(X1),VAL(C$(X1)),VAL(A$(X1))*VA
LIC1X11
1760 GOSUB2800
1780 NEXT X
1800 PRINT#-2:PRINT#-2
1820 PRINT#-2,TAB(40)"Shipping
";PRINT#-2,USING"
$###$.##";VAL(SH$)
1840 IF L*T=0 THEN 1880
1860 PRINT#-2,TAB(140)"Sales tax
";PRINT#-2,CHR
$(115):PRINT#-2,USING"$###$.##";
L*1
1880 PRINT#-2,CHR$(141)
1900 PRINT#-2,TAB(40)"Total":PR
INT#-2,USING"
$###$.##";IT*L)+T+VAL(SH$)+VA
LIC1$1
1920 PRINT#-2
1940 PRINT#-2,TAB(51)"Thank you."
1960 PRINT#-2
1980 IF PYS="C" OR PYS="e" THEN
GOSUB 2740
2000 IF PYS="M" OR PYS="m" THEN
GOSUB 2780
2020 IF PYS="Y" OR PYS="y" THEN
GOSUB 2820
2040 PRINT#-2:PRINT#-2
2060 PRINT#-2,TAB(150)"Your Name"
2080 PRINT#-2,TAB(150)"Your Addre
ss"
2100 PRINT#-2,TAB(50)"Your City,
State, Zip"
2120 PRINT#-2,TAB(50)"Your Phone
#, if you wish."
2140 PRINT#-2
2160 IF P5$="" THEN 2180
2180 PRINT#-2,TAB(51)"Note: ";PS$
2180 RETURN
2200 CLS:T=0
2220 LOCATE 5,0:PRINTPYS:PRINT"
Purchase Order
#":PP$
2240 LOCATE 50,0:PRINTD$
2260 LOCATE 5,2:PRINTA1$
2280 LOCATE 5,3:PRINTA2$
2300 LOCATE 5,4:PRINTA3$
2320 LOCATE 0,6:PRINTTAB(51):ATT

```

```

CoCo 3 Disk
The Listing: COCOP0
1 *COCO PO
2 *BY ROGER F. KRUEGER
3 *COPYRIGHT (C) 1992
4 *BY FALSOFT, INC.
5 *RAINBOW MAGAZINE
6 *WITH THANKS TO WILLIAM BOSTON
7 *FOR HIS PROGRAM IN
8 *THE RAINBOW - AUG 82, PG 19.
20 *THIS PROGRAM IS FOR THE
21 *COCO 3 USING AN RGB MONITOR.
40 * BY ROGER F. KRUEGER
60 * 14 BANK STREET
80 * DANSVILLE, NY 14437
85 * 17161 335-5611
100 *MAY 11, 1987
120 *FILENAME: COCOP0
140 WIDTH80
160 PALETTE RGB:PALETTE 1,0:CLS
2:ATTR 5,1
180 CLEAR 2000
200 GOSUB 3040
220 CLS
240 LOCATE 0,0:PRINTSTRING$(0,")
260 LOCATE 0,1:PRINT""
""
280 LOCATE 0,2:PRINT""
+ + + Purchase Order
""
300 LOCATE 0,3:PRINT""
""
320 LOCATE 0,4:PRINTSTRING$(0,")
%1
340 LOCATE 15,8:PRINT"1. Enter 0
ata 2. Load Data"
360 LOCATE 15,10:PRINT"3. Hardco
py 4. Display
380 LOCATE 15,12:PRINT"5. Quit
""
400 LOCATE 28,15:PRINT"Select 1-
5"
420 SOUND 200,1
440 GOSUB3000
460 IF VAL(K$)<1 OR VAL(K$)>5 TH

```



**RAINBOW**  
Back Issues  
Still Available

Most issues still available, see the back issue ad on Page 14 for details.

# PCM

The Complete Personal Computer Magazine for Today's Computer Users

**Covering the Complete Line of Popular Tandy MS-DOS and Portable Computers**

Call (502) 228-4492 for information.  
(800) 847-0409 for VISA/MC/AMEX orders.  
PCM is a registered trademark of Falsco, Inc.

## Advertisers Index

68xxx Machines .....	17	JWT Enterprises .....	17
Burke & Burke .....	9	MV Systems .....	19
Cer-Comp .....	13	Owl-Ware .....	7
Cer-Comp .....	23	PCM .....	31
CoCoPRO! .....	3	Rainbow Back Issues .....	14
Computer Plus .....	BC	Rainbow on Tape and Disk .....	12
Dayton Associates		Rainbow Subscription .....	11
of W.R. Hall, Inc. ....	27	Rick's Computer Enterprise .....	25
Delphi .....	21	Sebastian LaSpada .....	29
Eversoft Games, Ltd. ....	19	Sundog Systems .....	5
Farna Systems .....	15	Sundog Systems .....	31
Gale Force Enterprises .....	25	T & D Subscription Software .....	13
Granite Computer Systems .....	9	T & D Subscription Software .....	29
Hawksoft .....	31		



Call: Kim Lewis  
Advertising Representative

Call: Belinda Kibby  
Advertising Representative

The Falsco Building  
9509 U.S. Highway 42, P.O. Box 385, Prospect, KY 40059  
(502) 228-4492 • FAX (502) 228-5121

We appreciate your mentioning THE RAINBOW when you contact these advertisers.

# PHOTON

The critics will be raving about this strategy game! Based on an original concept by author Jeff Stedel, *Photon* is an addictive time-muncher in the spirit of *Temple*™ and *Terra*™. Match wits with Ludevid, the evil power droid, as you reason your way through over 60 devious levels. The numerous original music scores, digitized speech and sound effects, and pleasurable animation and graphics enrich *Photon* to make it an unparalleled gaming experience. Soon to be released on a variety of computer platforms, the CoCo Community is lucky enough to be given first glance at this fantastic game! Req. 128k CoCo-3, disk drive, and joystick.

**\$34.95**

## 50% OFF!

Sundog Systems is now offering outselected back-stock software, and you can now take advantage of these bargains to complete your Sundog collection! For a limited time, you can buy some of the best CoCo games at 50% off retail price! Half off factory-new game software...you'll never find a better deal!

Paladin's Legacy	reg. \$24.95	now \$12.45!
Hall of the King 1, 2, or 3	reg. \$29.95	now \$14.95!
Kung-Fu Dude	reg. \$24.95	now \$12.45!
White Fire of Eternity	reg. \$19.95	now \$9.95!
Dragon Blade	reg. \$19.95	now \$9.95!
Champion	reg. \$19.95	now \$9.95!



PO Box 766 Manassas, VA 22111  
(703) 330-8989

VISA, MC, check, MO, and COD (US only, please) accepted. All foreign shipments to be sent in US run only MO's. Includes \$2.50 for shipping in USA & Canada, \$5 foreign. \$3 extra for COD orders. PA residents add 6% tax.

Announcing

## Icon Basic09

The next programming language for OS-9!

Icon Basic09 is a graphical user interface (GUI) to Basic09, which will make programming easier than ever! Icon Basic09 takes an innovative approach by using graphic representations, or icons, to represent statements and keywords for writing Basic09 programs and procedures. Instead of constantly typing while writing a program, the user can simply **point & click** to choose the desired statement!

Icon Basic09 can also be very useful in studying procedures and programs written by others to learn how they operate. The package contains a full set of icons...or, you may edit or create icons using the included icon editor. Icon Basic09 requires a CoCo-3 with at least 256k, mouse or joystick, and OS-9 v 2.

**\$20**

<b>Dual hi-res joystick adapter</b> (RS/Colorware)	<b>\$40</b>
<b>Hi &amp; Lo-res joystick adapter</b>	<b>\$27</b>
<b>HAWKsoft keyboard extension cable</b>	<b>\$25</b>
<b>Domination</b> (*Risk*-like wargame!)	<b>\$18</b>
<b>MyDOS</b> full-featured DOS extension	<b>\$15</b>



PO Box 7112  
Elgin, IL 60121-7112  
(708) 742-3084 eves & ends

US and CDN S&H always included. Terms: MO, check, or COD.

From Computer Plus to YOU . . .  
**PLUS after PLUS after PLUS**



Tandy 1110 HD \$929\*  
 Tandy 1800 HD \$929\*  
 Tandy 3820 \$2499



Tandy 2500 SX/25 HD \$1099.00  
 Tandy 4825 SX/25 HD \$1739



Tandy 4850 EP \$2399



DMP-136 \$199\*



**Sold out**

Color Computer Disk Drive  
 Drive 0 \$239 Drive 1 \$149



TandyFax 1500 \$539\*

**BIG SAVINGS ON A FULL COMPLEMENT OF RADIO SHACK COMPUTER PRODUCTS**

**COMPUTERS**

Tandy 1000 RLX HD with VGM-220	839.00
Tandy 1110 HD 1 Drive 640K	929.00 *
Tandy 1800 HD 1 Drive 1 Meg RAM	929.00 *
Tandy 1000 RL HD with CM11	569.00 *
Tandy 1100 FD 1 Drive 640K	469.00 *

**PRINTERS**

Tandy DMP-136 213 CPS	199.00 *
Tandy DMP-302 270 CPS	469.00
Tandy DMP-202 180 CPS	299.00
Tandy DMP-442 300 CPS	539.00
Tandy LP-950 Laser Printer	1299.00
Tandy DMP-240 192 CPS 8 color	399.00
Panasonic KXP 1180 192 CPS	189.00 *
Panasonic KXP 1123 24 Wirehead	259.00
Panasonic KXP 1124 1300 CPS	329.00
Okidata 320 300 CPS	369.00
Okidata 380 180 CPS 24 Wire HD	239.00
OKI Laser 400 4PPM	679.00 *

**MODEMS**

Tandy DCM-6	52.00
Tandy DCM-7	85.00
Cardinal 1200 Baud External	99.00
Cardinal 2400 Baud External	129.00

**COLOR COMPUTER MISC.**

Tandy Drive Controller	89.00 *
Extended Basic Rom Kit (28 pin)	19.95
64K Ram Upgrade Kit (2 or 8 chip)	39.00
Tandy Deluxe Keyboard Kit	24.95
Hi-RES Joystick Interface	8.95
Color Computer Deluxe Mouse	44.00
Multi Pak Pal Chip for COCO 3	14.95
COCO 3 Service Manual	29.95
Serial to Parallel Converter	59.95
Tandy Deluxe Joystick	19.95
Magnavox 8135 RGB Monitor	299.00
Magnavox Green or Amber Monitor	99.00
CoCo 3 Game Chip	29.95
Tandy Pistol Grip Joystick	26.95
PBJ OK COCO 3 Upgrade Board	29.95
PBJ 512K COCO 3 Upgrade	89.00
Tandy OK COCO 3 Upgrade Board	39.95
Tandy 512K COCO 3 Upgrade	99.00 *

**COLOR COMPUTER SOFTWARE**

	TAPE	DISK
The Wild West (COCO 3)	25.95	25.95
Worlds of Flight	34.95	34.95
Mustang P-51 Flight Simul.	34.95	34.95
Flight 16 Flight Simul.	34.95	34.95

Tandy Educational Software	2.00
Spinnaker Software	2.00
Max 10 by Colorware	79.95
AutoTerm by PXE Computing	29.95
TW-60 by Spectrum (COCO 3)	39.95
TeleWriter 64	49.95
TeleWriter 128	59.95
Elite Word 80	79.95
Elite Calc 3.0	69.95
CoCo 3 512K Super Ram Disk	19.95
Home Publishing by Tandy (CoCo 3)	35.95
Sub Battle Sim. by Epyx (CoCo 3)	26.95
Thexder by Sierra (CoCo 3)	22.45
Kings Quest III by Sierra (CoCo 3)	31.45
Flight Sim. II by SubLogic (CoCo 3)	31.45
OS-9 Level II by Tandy	71.95
OS-9 Development System	89.95
Multi-View by Tandy	44.95
VIP Writer (disk only)	69.95
VIP Integrated Library (disk)	149.95

Prices are subject to change without notice. Please call for shipping charges. Prices in our retail store may be higher. Send for complete catalog.

\*Sale prices through 8-10-92

**CALL TOLL FREE**  
**1-800-343-8124**

- LOWEST POSSIBLE PRICES
- BEST POSSIBLE WARRANTY
- KNOWLEDGEABLE SALES STAFF
- TIMELY DELIVERY
- SHOPPING CONVENIENCE



**computer plus**

P. O. Box 1094  
 480 King Street  
 Littleton, MA 01460

SINCE 1973

IN MASSACHUSETTS CALL (508) 486 3193